

CLINICAL PROTOCOL

Date: July 26, 2022	Phase: Phase 3 Study	Protocol No.: GC-012
------------------------	-------------------------	-------------------------

NCT03868124

**PROSPECTIVE, RANDOMIZED PHASE 3 STUDY
COMPARING TWO MODELS OF A TRAVOPROST
INTRAOCULAR IMPLANT TO TIMOLOL
MALEATE OPHTHALMIC
SOLUTION, USP, 0.5%**

PROTOCOL #GC-012

REVISION #: REV 4

DATE: JULY 26, 2022

Sponsor:

GLAUKOS CORPORATION

229 Avenida Fabricante | San Clemente, CA 92672 | (949) 367-9600

CLINICAL PROTOCOL

Date: July 26, 2022	Phase: Phase 3 Study	Protocol No.: GC-012
------------------------	-------------------------	-------------------------

INVESTIGATOR SIGNATURE PAGE

I have read this study protocol and agree that it contains all the information required to implement and conduct this study diligently and in strict compliance with the protocol, good clinical practices (GCP) and all applicable laws and regulations.

Maintain all information supplied by Glaukos in confidence, and when this information is submitted to an institutional review board (IRB), independent ethics committee (IEC) or another group, it will be submitted with a designation that the material is confidential.

Ensure that all persons assisting with the trial are adequately informed about the protocol, the investigational product(s), and their trial-related duties and functions.

Name of Investigator (Print) Signature *Date

***Date of signature indicates date of approval**

Acknowledged By Sponsor:

Name and Title (Print) Signature of Sponsor Date

CLINICAL PROTOCOL

Date: July 26, 2022	Phase: Phase 3 Study	Protocol No.: GC-012
------------------------	-------------------------	-------------------------

GLAUKOS CONTACT INFO

Sponsor:

[REDACTED]

Medical Monitor:

[REDACTED]

Study Lead:

[REDACTED]

CLINICAL PROTOCOL

Date: July 26, 2022	Phase: Phase 3 Study	Protocol No.: GC-012
------------------------	-------------------------	-------------------------

Table of Contents

1	INTRODUCTION	11
2	OBJECTIVE	12
3	CLINICAL HYPOTHESIS	12
4	STUDY DESIGN	12
4.1	Discussion of Study Design	15
5	STUDY MEASURES	15
5.1	Efficacy Measures	15
5.2	Safety Measures	15
6	MATERIALS	16
6.1	Study Medications.....	16
6.1.2	CONTROL ARTICLE: TIMOLOL MALEATE OPHTHALMIC.....	18
7	METHODS.....	19
7.1	Subjects	19
7.2	Eligibility Requirements	19
7.3	Procedures	26
7.4	Concomitant Therapies	44
7.5	Post-Treatment Management of IOP and Rescue Medications	44
8	EXTENT OF EXPOSURE AND TREATMENT COMPLIANCE	48
9	STATISTICAL ANALYSES	48
9.1	Sample Size	48
9.2	Analysis Populations	49
9.3	General Statistical Methods	50
9.4	Safety Analyses	50
9.5	Efficacy Endpoints	51
9.6	Interim Analyses	53
10	ADVERSE EVENTS	53
10.1	Serious Adverse Event	56
10.2	Unexpected Adverse Event	56
10.3	Suspected, Unexpected, Serious, Adverse Event (SUSAR)	57
10.4	Adverse Events Follow-up.....	57

CLINICAL PROTOCOL

Date: July 26, 2022	Phase: Phase 3 Study	Protocol No.: GC-012
------------------------	-------------------------	-------------------------

11	MAINTAINING THE MASK.....	57
12	INFORMED CONSENT.....	58
13	INSTITUTIONAL REVIEW	58
14	CONFIDENTIALITY/PUBLICATION OF THE STUDY	58
15	STATEMENT OF COMPLIANCE	59
16	RECORD KEEPING.....	59
16.1	Source Documents.....	59
16.2	Data Collection.....	60
16.3	Study Supply Accountability	60
16.4	Record Retention.....	60
17	REFERENCES	61

List of Figures

Figure 1.	Glaukos Travoprost Intraocular Implant	17
Figure 2.	Glaukos Travoprost Intraocular Implant and Inserter	17
Figure 3.	Post-Treatment Management of IOP and Rescue Medications.....	47

List of Appendices

APPENDIX A:	SCHEDULE OF VISITS AND MEASUREMENTS	62
APPENDIX B:	OBLIGATIONS OF THE INVESTIGATOR.....	63
APPENDIX C:	DECLARATION OF HELSINKI	65

CLINICAL PROTOCOL

Date: July 26, 2022	Phase: Phase 3 Study	Protocol No.: GC-012
------------------------	-------------------------	-------------------------

SYNOPSIS

This randomized, controlled, double-masked (subject and observer) clinical trial intends to randomize approximately 558 male and female subjects over 18 years old who have been diagnosed with open-angle glaucoma (OAG) or ocular hypertension (OHT). All subjects are required to meet eligibility criteria at Visit 1 (Screening) and unmedicated IOP inclusion criteria at Visit 2 (Baseline). The purpose of this study is to evaluate the IOP-lowering effect of each of two investigational implanted medication treatments, as compared to a control topical medication treatment. After completing Visit 2 (Baseline), subjects will be randomized in a 1:1:1 allocation to one of three study treatment arms: model G2TR-████ implant (test) arm, model G2TR-████ implant (test) arm, and topical timolol (control) arm. Postoperatively, there are 16 follow-up visits over a three-year period. Specular microscopy photos will be collected at selected sites.

IND Study Phase: 3

Test Article(s): Travoprost Intraocular Implant, high elution rate
(Model G2TR-████), ██████
Travoprost Intraocular Implant, low elution rate
(Model G2TR-████), ██████

Concurrent Control: Timolol Maleate Ophthalmic Solution, USP, 0.5%
(timolol)

STUDY OBJECTIVE

To compare the safety and initial efficacy of intraocular implants containing travoprost at two different elution rates versus Timolol Maleate Ophthalmic Solution, USP, 0.5% (timolol) in reducing elevated intraocular pressure in subjects with open-angle glaucoma (OAG) or ocular hypertension (OHT).

STUDY TREATMENTS

There are three treatment groups in this study, with medications administered as follows:

CLINICAL PROTOCOL

Date: July 26, 2022	Phase: Phase 3 Study	Protocol No.: GC-012
------------------------	-------------------------	-------------------------

	Surgical Procedure	Postoperative Drops	Active Components
Model G2TR- [REDACTED] Implant Group	Intraocular implantation	Placebo eye drops	Travoprost
Model G2TR- [REDACTED] Implant Group	Intraocular implantation	Placebo eye drops	Travoprost
Control Group	Sham surgery	Active comparator eye drops	Timolol Maleate Ophthalmic Solution, USP, 0.5%

After undergoing either an implantation or sham procedure, masked topical study drops will be used by all subjects twice a day for the duration of the study. For the implant groups, the study medication will be placebo eye drops (artificial tears). For the control group, the study medication will be masked active comparator eye drops (timolol medication) as described above used for the duration of the study.

CLINICAL HYPOTHESES

- Intraocular implants containing travoprost are at least as effective as timolol in achieving lowered intraocular pressure (IOP) in subjects with open-angle glaucoma (OAG) or ocular hypertension (OHT)
- Intraocular implants containing travoprost are well-tolerated

Structure: Parallel groups

Number of Centers: [REDACTED]

Masking: [REDACTED]

Method of Subject Assignment:
After the 4:00 PM IOP measurement at Visit 2 (Baseline), qualified subjects will be scheduled to undergo treatment with the G2TR- [REDACTED] implant, the G2TR- [REDACTED] implant, or timolol drops in an allocation of 1:1:1.

Randomization: Yes

Total Sample Size: Approximately 558 subjects

Statistical Rationale Provided: Please refer to Statistical Section, [Section 9](#)

CLINICAL PROTOCOL

Date: July 26, 2022	Phase: Phase 3 Study	Protocol No.: GC-012
------------------------	-------------------------	-------------------------

STUDY OVERVIEW

Subjects will be assessed for inclusion/exclusion criteria at Visit 1 (Screening), and subjects who meet criteria at Visit 1 (Screening) and are using hypotensive medication will undergo a medication washout; subjects who are not using hypotensive medication may be scheduled for Visit 2 (Baseline) (on a separate day). At Visit 2 (Baseline), all subjects must have a mean diurnal IOP of [REDACTED]. In addition, the IOP at each timepoint (8AM, 10AM, and 4PM) is [REDACTED] in the study eye, and meet all other entry criteria.

Visit Schedule:

This study will consist of [REDACTED] visits over a 3-year period: Visit 1 (Screening), Visit 2 (Baseline), Visit 3 (Operative Day 0), Visit 4 (Day 1-2), Visit 5 (Day 10), Visit 6 (Week 4), Visit 7 (Week 6), Visit 8 (Month 3), [REDACTED]

[REDACTED]

Study Measures:

Efficacy Measure

The efficacy measurement in this study is change from baseline IOP in the study eye. The primary evaluation will be based on IOP through 3 months postoperative.

Key Safety Measures

- Intra-operative Adverse events
- Post-operative Adverse events
- Corrected visual acuity (logMAR score using ETDRS chart)
- Slit-lamp biomicroscopy findings
- Gonioscopy findings
- Specular microscopy (at selected sites)
- Ophthalmoscopy findings
- Visual field evaluation

Specified Plan for Data Analysis: Yes (refer to Statistical Section, [Section 9](#))

Power and Sample Size:

[REDACTED]

CLINICAL PROTOCOL

Date: July 26, 2022	Phase: Phase 3 Study	Protocol No.: GC-012
------------------------	-------------------------	-------------------------

[REDACTED]

In order to detect adverse events that occur at a rate of [REDACTED] or higher, safety in the clinical program will be demonstrated in a minimum of [REDACTED] subjects who have completed the expected duration of drug elution from either implant model. Approximately 186 subjects will be randomized to each treatment group in a 1:1:1 allocation. A similar second pivotal trial will also be conducted as part of the clinical program. In addition, approximately 100 subjects were randomized to receive one of the two implant models in a prior Phase 2 study (Protocol GC-009).

[REDACTED] see [Section 9](#)).

STUDY VARIABLES AND STATISTICAL ANALYSIS

Efficacy Variable

The primary efficacy variable will be change from baseline IOP in the study eye at each diurnal timepoint specified below.

Safety Variables

Adverse events (intra-operative and post-operative [TEAEs]) in the study will be monitored and summarized.

Ocular safety variables, i.e., best spectacle corrected visual acuity, biomicroscopy findings, gonioscopy findings, specular microscopy findings (at selected sites), ophthalmoscopy findings (including cup-to-disc ratio), and visual field evaluation, will be summarized. In addition, changes from Visit 2 (Baseline) in ocular findings (e.g., conjunctival hyperemia, iris changes) will be assessed.

Analysis Populations

Refer to Statistical Analysis Section ([Section 9](#)).

CLINICAL PROTOCOL

Date: July 26, 2022	Phase: Phase 3 Study	Protocol No.: GC-012
------------------------	-------------------------	-------------------------

LIST OF ABBREVIATIONS AND DEFINITION OF TERMS

Abbreviation/Term	Definition
α -agonists	α -adrenergic receptor agonists
ALT	Argon laser trabeculoplasty
AE	Adverse Event
BAK	Benzalkonium chloride
β -blockers	β -adrenergic receptor antagonists
BSCVA	Best Spectacle Corrected Visual Acuity
CAI	Carbonic Anhydrase Inhibitor
CI	Confidence Interval
CRF	Case Report Form
ETDRS	Early Treatment of Diabetic Retinopathy Study
FDA	Food and Drug Administration
GCP	Good Clinical Practice
IOP	Intraocular Pressure
IEC	Independent Ethics Committee
IRB	Institutional Review Board
ITT	Intent-To-Treat
LogMAR	Logarithm of the Minimum Angle of Resolution
MA	Medical Affairs
MLT	MicroPulse Laser Trabeculoplasty
MedDRA	Medical Dictionary for Regulatory Activities
mmHg	Millimeters of mercury
OAG	Open-Angle Glaucoma
OHT	Ocular Hypertension
PAS	Peripheral Anterior Synechia
PGA	Prostaglandin analogue
PP	Per Protocol
ROCK	Rho Kinase Inhibitors
SAE	Serious Adverse Event
SAP	Statistical Analysis Plan
SLT	Selective Laser Trabeculoplasty
TEAE	Treatment Emergent Adverse Event
VA	Visual acuity

CLINICAL PROTOCOL

Date: July 26, 2022	Phase: Phase 3 Study	Protocol No.: GC-012
------------------------	-------------------------	-------------------------

1 INTRODUCTION

Glaucoma is a group of eye diseases characterized by progressive, irreversible and largely asymptomatic vision loss caused by optic nerve damage, which is most commonly associated with elevated levels of intraocular pressure.

Glaucoma is a chronic condition that progresses slowly over long periods of time and can have a devastating impact on a patient's vision and quality of life. Reducing intraocular pressure currently is the only proven treatment for glaucoma.

Treatment for open-angle glaucoma (OAG) traditionally has started with topical ocular hypotensive medical therapy. Development of more effective medications has increased the popularity of this approach as initial treatment compared to more invasive incisional or drainage device surgery.

Furthermore, the more benign medication treatments preserve the ocular tissues in the event that more invasive surgical approaches are eventually required.

The various topical ocular medications available to reduce IOP include miotics, β -adrenergic receptor antagonists (β -blockers), carbonic anhydrase inhibitors (CAIs), α -adrenergic receptor agonists (α -agonists), and prostaglandin analogues (PGAs). The PGAs are a class of ocular hypotensive agents that have been proven effective in lowering IOP in subjects with OAG or OHT. Other advantages of this class of medications is that the systemic side effects associated with α -agonists (e.g., dry mouth, drowsiness) and β -blockers (e.g., depression, fatigue, bradycardia) do not appear to be associated with PGAs. Furthermore, the ocular side effects typically associated with α -agonists (e.g., allergic reactions), and cholinergic agents (e.g., reduced vision), do not seem to manifest with the use of PGAs.

However, PGAs have been shown to be associated with side effects such as ocular hyperemia, iris hyperchromia, periorbital atrophy, increased eyelash growth, general ocular surface discomfort and headache.¹⁻⁵ These side effects and other factors including cost, compliance, and the difficulty of proper instillation, can sometimes hinder the proper use of topical medications.^{6,7} Some patients may possess or develop an intolerance to topical medications or the preservatives in their formulations.

The Travoprost Intraocular Implant was developed to remove or minimize the issue of patient compliance with topical hypotensive medication. This clinical protocol will evaluate two versions of the Travoprost Intraocular Implant: Model G2TR-████ and Model G2TR-████. The implants are identical except that they are designed to elute travoprost at two different elution rates.

CLINICAL PROTOCOL

Date: July 26, 2022	Phase: Phase 3 Study	Protocol No.: GC-012
------------------------	-------------------------	-------------------------

For the purposes of this protocol, Model G2TR- [REDACTED] is the high elution rate implant and Model G2TR- [REDACTED] is the low elution rate implant.

These implants have the potential for providing important benefits to patients. The long duration of drug therapy provided by the implants avoids the problem of compliance with topical ocular hypotensive medications. [REDACTED]

Earlier versions of both models of the implant have been investigated in clinical trials conducted in [REDACTED] (Phase 1/2) as well as the United States (Phase 2). The results from the U.S. Phase 2 trial have demonstrated that the Model G2TR- [REDACTED] and G2TR- [REDACTED] implants have long-term IOP-lowering effects and are also generally well-tolerated by study subjects. These results support the continued evaluation of the implant models in a Phase 3 trial.

2 OBJECTIVE

The objective of this study is to evaluate the safety and efficacy of intraocular implants that elute travoprost at two different elution rates. Specifically, the Travoprost Intraocular Implant Model G2TR- [REDACTED] (high elution rate) and the Travoprost Intraocular Implant Model G2TR- [REDACTED] (low elution rate). Both implants will be compared to Timolol Maleate Ophthalmic Solution, USP, 0.5% (timolol) for reducing intraocular pressure in subjects with open-angle glaucoma (OAG) or ocular hypertension (OHT).

3 CLINICAL HYPOTHESIS

The following are the hypotheses for the study:

- Intraocular implants containing travoprost are at least as effective as timolol in achieving lowered intraocular pressure (IOP) in subjects with OAG or OHT.
- Intraocular implants containing travoprost are well-tolerated.

4 STUDY DESIGN

This is a prospective, randomized, double-masked, active-controlled, parallel-group, multi-center clinical trial comparing the efficacy and safety of the Model G2TR- [REDACTED] Travoprost Intraocular Implant and the Model G2TR- [REDACTED] Travoprost Intraocular Implant to topical timolol in subjects with OAG or OHT. Approximately 558 subjects will be randomized in this study and will be followed through 3 years postoperative. [REDACTED]

CLINICAL PROTOCOL

Date: July 26, 2022	Phase: Phase 3 Study	Protocol No.: GC-012
------------------------	-------------------------	-------------------------

Screening Procedure:

After providing informed consent, prospective subjects will be evaluated against the screening criteria.

Subjects who qualify at Visit 1 (Screening) and have not used topical ocular hypotensive medications prior to Visit 1 (Screening) or who were on a topical ocular hypotensive medication but have stopped for the length of time in the washout schedule below do not require a washout period and may be scheduled for Visit 2 (Baseline) (on a separate day).

Subjects who qualify at Visit 1 (Screening), that were previously on a topical IOP lowering medication, but discontinued prior to Visit 1 (Screening) and are still within the protocol defined washout period will continue the medication washout according to the schedule below and will have Visit 2 (Baseline) scheduled to occur after the washout is completed.

Subjects who qualify at Visit 1 (Screening) and are using any topical IOP-lowering medication in either eye will undergo medication washout according to the schedule below and Visit 2 (Baseline) will be scheduled to occur after the washout is completed.

If both eyes qualify at Visit 1 (Screening), the investigator may choose to implement a bilateral washout according to the following schedule:

- [REDACTED]

Following the required washout period, subjects will return for Visit 2 (Baseline). The mean diurnal IOP measured at Visit 2 (Baseline) must be [REDACTED]. In addition, the and the IOP at each timepoint (8AM, 10AM, and 4PM) is [REDACTED] in the study eye, in addition to all other entry criteria. The investigator will then designate the qualified eye as the study eye; if both eyes qualify, the RIGHT eye will be selected as the study eye. The subject may then be scheduled for study treatment. Subjects will be treated unilaterally, only one eye will go through the study treatment. [REDACTED]

[REDACTED]

CLINICAL PROTOCOL

Date: July 26, 2022	Phase: Phase 3 Study	Protocol No.: GC-012
------------------------	-------------------------	-------------------------

Treatment Procedure:

The Operative and Postoperative scheduled visits are listed in the following table:

Visit Number	Visit Timepoint	Visit Number	Visit Timepoint

At Visit 3 (Operative Day 0), subjects will be randomized to receive one of the three study treatments in a 1:1:1 allocation.

According to randomization, the operative exam for each subject will entail implantation with the high-elution model implant; the low-elution model implant; or a sham procedure.

Following the procedure, all subjects will be provided with masked study medication for the duration of the study and instructed to instill one drop in the designated study eye twice daily at approximately [redacted]. The first dose will be instilled the evening of the operative exam.

- [redacted]

At Visit 2 (Baseline), Visit 5 (Day 10), Visit 7 (Week 6), Visit 8 (Month 3), diurnal IOP will be measured at 8:00 AM ± 30 minutes, 10:00 AM ± 30 minutes, AND 4:00 PM ± 30 minutes.

Standard IOP measurements will be taken once daily at one of three timepoint options on any given visit day (8:00 AM ± 30 minutes, 10:00 AM ± 30 minutes, OR 4:00 PM ± 30 minutes). Study follow-up will continue until [redacted] after which subjects will be exited from the study.

CLINICAL PROTOCOL

Date: July 26, 2022	Phase: Phase 3 Study	Protocol No.: GC-012
------------------------	-------------------------	-------------------------

4.1 Discussion of Study Design

To qualify for the study, subjects currently using topical ocular hypotensive medication will be required to complete a washout of their medications according to the schedule described above. These washout intervals were chosen to ensure that the diurnal IOP measurements obtained at Visit 2 (Baseline) adequately represent the subjects' untreated IOP. They are also in accordance with the intervals included in the recent trials conducted for other anti-glaucoma agents.

To provide a comparative evaluation of the efficacy and safety of the travoprost-eluting implant, [REDACTED] Consistent with the current FDA-approved labeling, [REDACTED] In order to facilitate masking of the study medications, subjects assigned to the implant groups will be instructed to instill their study medication in the morning (approximately 8:00 AM) and in the evening (approximately 8:00 PM).

5 STUDY MEASURES

5.1 Efficacy Measures

The primary efficacy measure in this study is change from baseline IOP, measured in the study eye at 8:00 AM ± 30 minutes and 10:00 AM ± 30 minutes. Diurnal IOP measurements will be taken at Visit 2 (Baseline), Visit 5 (Day 10), Visit 7 (Week 6), and Visit 8 (Month 3). The primary efficacy endpoint will be based on the difference in mean change from baseline IOP, between each test group and the control group, for the IOP measurement times specified above at each of the Visit 5 (Day 10), Visit 7 (Week 6), and Visit 8 (Month 3) follow-up visits.

[REDACTED]

5.2 Safety Measures

Ocular safety measures include intra-operative adverse events, post-operative adverse events (TEAEs), corrected visual acuity, slit lamp biomicroscopy findings, gonioscopy findings, specular microscopy findings (at selected

CLINICAL PROTOCOL

Date: July 26, 2022	Phase: Phase 3 Study	Protocol No.: GC-012
------------------------	-------------------------	-------------------------

sites), ophthalmoscopy findings (including cup-to-disc ratio), and visual field evaluation. Note: See [APPENDIX A](#) for a schedule of visits and assessments.

6 MATERIALS

6.1 Study Medications

Subjects randomized to the implant groups in the study will undergo surgery to receive the implants using the test articles described below in [Section 6.1.1](#), before receiving their placebo eye drops. [REDACTED]

Subjects randomized to the control group will undergo a sham procedure (pretend surgery) using a needleless syringe (as described in [Section 6.1.4](#), Other Articles: Sham Procedure) [REDACTED]

During the study period, bottles of study medication will be dispensed to all subjects at Visit 3 (Operative Day 0), Visit 8 (Month 3), [REDACTED]

**6.1.1 TEST ARTICLES: MODELS G2TR-[REDACTED] AND G2TR-[REDACTED]
TRAVOPROST INTRAOCULAR IMPLANTS**

The Travoprost Intraocular implant is a [REDACTED]

CLINICAL PROTOCOL

Date: July 26, 2022	Phase: Phase 3 Study	Protocol No.: GC-012
------------------------	-------------------------	-------------------------

Figure 1. Glaukos Travoprost Intraocular Implant

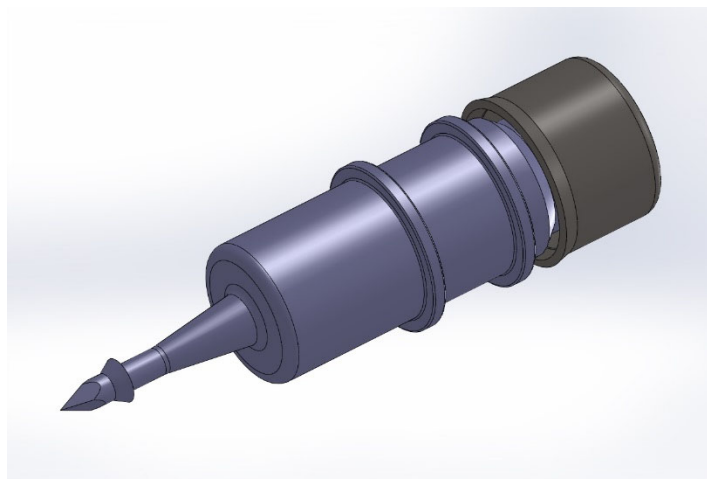

The Travoprost Intraocular Implant is provided sterile and pre-loaded onto an inserter in a blister tray, pouch and unit carton. Each tray lid is labeled with the required product identification information. The surgeon should use the provided pre-loaded inserter to implant the product.

The inserter (Figure 2) is a sterile, single-use insertion system, pre-loaded with one implant, and designed to deliver the implant through the trabecular meshwork to the implant site.

Figure 2. Glaukos Travoprost Intraocular Implant and Inserter

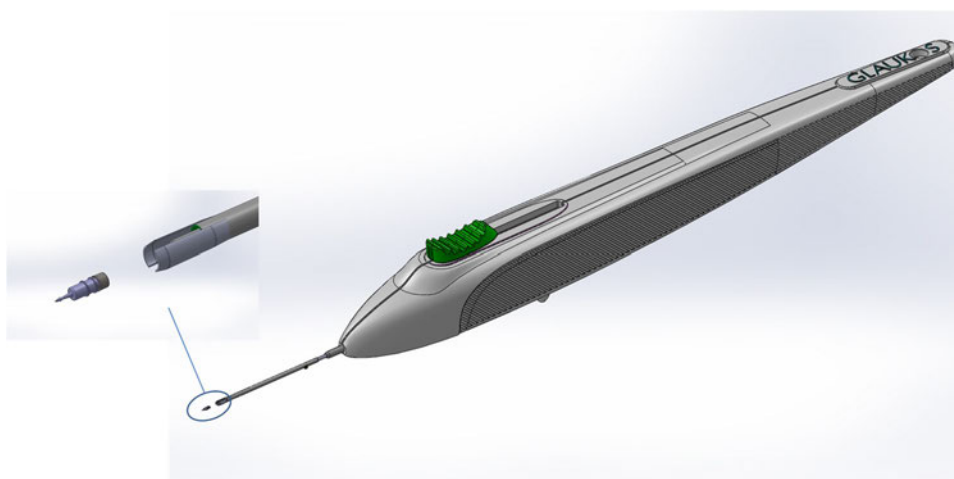

Each unique product is packaged in a pouch and outer carton labeled with the study number, unique kit number, and instructions (including storage conditions).

CLINICAL PROTOCOL

Date: July 26, 2022	Phase: Phase 3 Study	Protocol No.: GC-012
------------------------	-------------------------	-------------------------

[REDACTED]

6.1.2 CONTROL ARTICLE: TIMOLOL MALEATE OPTHALMIC SOLUTION

For subjects randomized to the control group:

Each mL of solution contains timolol [REDACTED]

[REDACTED]

Each bottle is packaged in an outer carton labeled with the study number, unique kit number, and instructions [REDACTED]

[REDACTED]

6.1.3 OTHER ARTICLES: ARTIFICIAL TEARS

For subjects randomized to the intraocular implant treatment group:

Advanced Eye Relief Dry Eye Rejuvenation [REDACTED] are to be used as placebo eye drops. [REDACTED]

[REDACTED]. Each

bottle is packaged in an outer carton labeled with the study number, unique kit number, and instructions [REDACTED]

[REDACTED]

6.1.4 OTHER ARTICLES: SHAM PROCEDURE

For subjects randomized to the topical medication control group: The syringe used for the sham procedure is a packaged [REDACTED] syringe. Each syringe is packaged in a pouch and outer carton labeled with the study number, unique kit number, and instructions (including storage conditions).

[REDACTED]

CLINICAL PROTOCOL

Date: July 26, 2022	Phase: Phase 3 Study	Protocol No.: GC-012
------------------------	-------------------------	-------------------------

7 METHODS

7.1 Subjects

Approximately 558 subjects diagnosed with OAG or OHT will be randomized at approximately [REDACTED] primarily in the United States and international sites. After signing informed consent, prospective subjects will be evaluated to determine whether they meet Visit 1 (Screening) criteria. Subjects who qualify at Visit 1 (Screening) must meet all other eligibility requirements at Visit 2 (Baseline). [REDACTED]

7.2 Eligibility Requirements

7.2.1 INCLUSION CRITERIA

7.2.1.1 Visit 1 (Screening) Inclusion Criteria

At the Visit 1 (Screening), all subjects must meet the following criteria:

1) Subject status as follows:

- a. male or female, 18 years of age or older
- b. [REDACTED]

[REDACTED]

[REDACTED]

2) Diagnosis of either OAG (i.e. primary, pseudoexfoliation, or pigmentary glaucoma) or OHT.

Subjects with OAG should have the following:

- a. Diagnosis of OAG
- b. Vertical C/D ratio ≤ 0.8
- c. [REDACTED]

[REDACTED]

CLINICAL PROTOCOL

Date:	Phase:	Protocol No.:
July 26, 2022	Phase 3 Study	GC-012

All subjects (OAG and OHT) must meet the rest of the following criteria:

3) Ocular hypotensive medication regimen as follows:

a.

[Redacted]

[Redacted]

CLINICAL PROTOCOL

Date: July 26, 2022	Phase: Phase 3 Study	Protocol No.: GC-012
------------------------	-------------------------	-------------------------

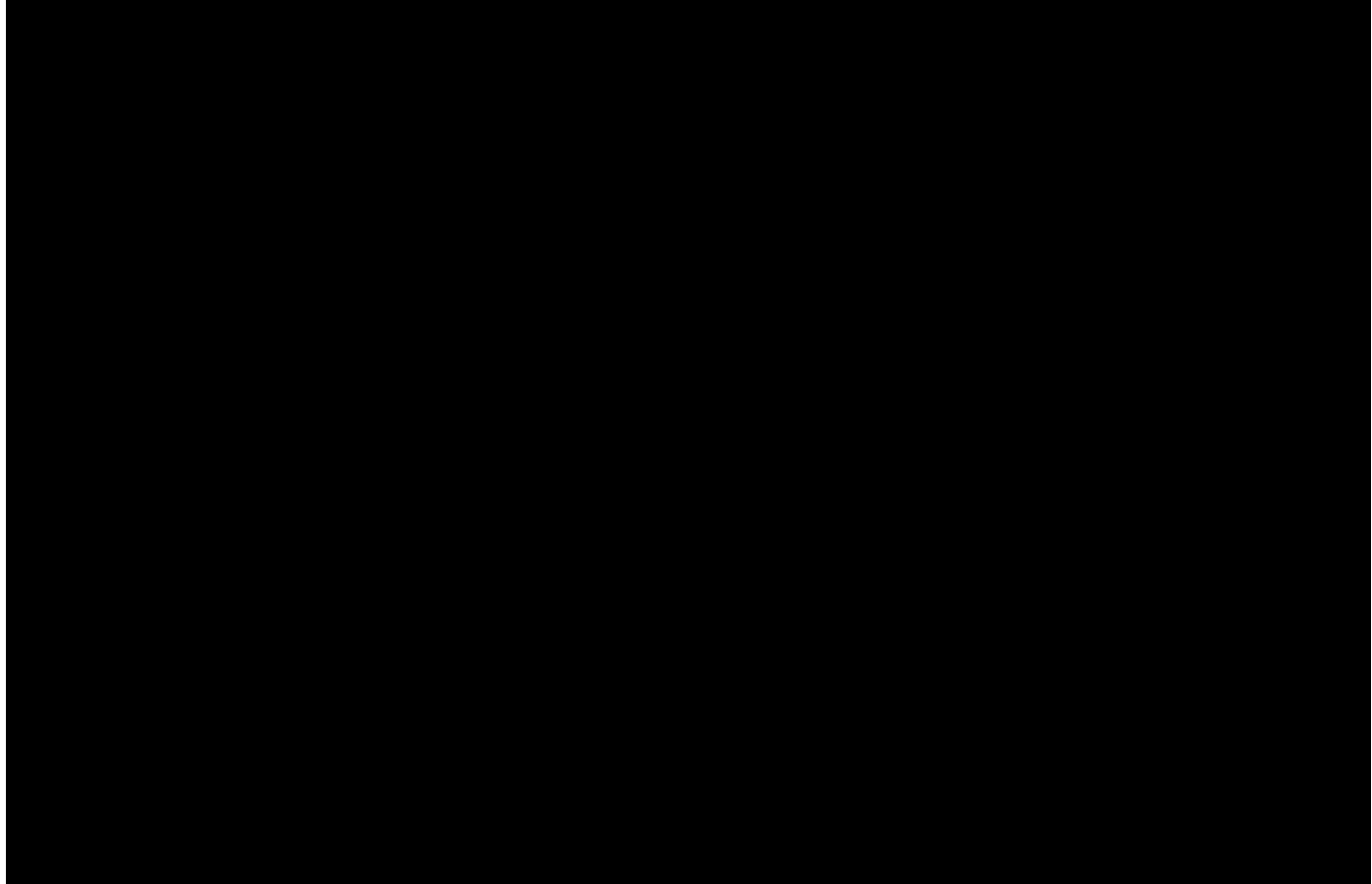

7.2.2 EXCLUSION CRITERIA

7.2.2.1 Visit 1 (Screening) Exclusion Criteria

Subjects who meet any of the following criteria in the study eye at Visit 1 (Screening) are not eligible to participate in the study:

- 1) A list item starting with '1)' followed by a large black redaction box that obscures the entire text of the criterion.

CLINICAL PROTOCOL

Date: July 26, 2022	Phase: Phase 3 Study	Protocol No.: GC-012
------------------------	-------------------------	-------------------------

2) [REDACTED]

3) Corneal status as follows:
a. any active inflammation [REDACTED]

4) [REDACTED]

6) Retinal or optic nerve disorders, [REDACTED]

CLINICAL PROTOCOL

Date: July 26, 2022	Phase: Phase 3 Study	Protocol No.: GC-012
------------------------	-------------------------	-------------------------

7) Other ocular status as follows:

a. clinically significant sequelae from trauma (e.g., chemical

[REDACTED]

8)

[REDACTED]

9)

[REDACTED]

CLINICAL PROTOCOL

Date: July 26, 2022	Phase: Phase 3 Study	Protocol No.: GC-012
------------------------	-------------------------	-------------------------

- i. known allergy, hypersensitivity or contraindication to the study

[REDACTED]

7.2.2.2

[REDACTED]

[REDACTED]

CLINICAL PROTOCOL

Date: July 26, 2022	Phase: Phase 3 Study	Protocol No.: GC-012
------------------------	-------------------------	-------------------------

7.2.3 CRITERIA FOR EARLY STUDY EXIT

Subjects may voluntarily withdraw from the study at any time. The investigator may elect to discontinue any subject for reasons unrelated to the study product. Details of a subject's exit from the study should be recorded in the subject's clinical records. Subjects exited after signing the informed consent form and prior to study completion will be handled as follows:

7.2.3.1 Prior to Randomization

Subjects will be ineligible for the study if they fail to meet Visit 1 (Screening) criteria, baseline criteria or randomization criteria as outlined in [Section 7.2](#), if they withdraw consent, or if study randomization goals have been met.

7.2.3.2 After Randomization

Subjects may be exited (discontinued) from the study in the event of a condition that may cause them harm if participation were to be continued. Subjects may also withdraw voluntarily.

7.2.3.3 Lost to Follow-up

Subjects who miss postoperative study visits and cannot be contacted within a reasonable timeframe via letter or telephone, will be considered lost to follow-up. The site will make at least three attempts to contact the subject via telephone. If unsuccessful, the site will send a registered letter with return receipt to the subject. The letter will request the subject to contact and return to the study site. If the subject does not contact the site within a week after the letter was received, he/she will be considered lost to follow-up, and the site will send a second registered letter (with return receipt) to notify the subject of study exit due to lack of response to the telephone calls and first registered letter. A Study Exit CRF may then be completed for the subject.

All attempts to contact the subject (including telephone call logs, copies of registered letters and registered letter receipts) must be documented and maintained with the subject's study source documentation.

CLINICAL PROTOCOL

Date: July 26, 2022	Phase: Phase 3 Study	Protocol No.: GC-012
------------------------	-------------------------	-------------------------

7.2.4 STUDY TERMINATION

The study may be terminated by Glaukos at any time following appropriate notification to the study sites and subjects.

7.3 Procedures

Study visits and assessments are listed below; a table overview of study procedures by visit is provided in [APPENDIX A](#) Schedule of Visits.

7.3.1 DURATION OF STUDY

Following any required washout period, the treatment period will be three years in duration.

7.3.2 METHODS TO MONITOR SUBJECT COMPLIANCE

In order to obtain reliable efficacy and safety data, it is critical that each study subject complies with the dosing schedule specified in this protocol. The following precautions will be taken to assure subject compliance during the study:

- a. For all 8 AM IOP measurements post-randomization, [REDACTED]
- b. Subjects will receive instructions regarding the proper instillation of study medication and the dosing regimen.

7.3.3 ENROLLMENT

All subjects must give written informed consent before undergoing any study-related change in their treatment or any study related procedures.

7.3.4 PREOPERATIVE PROCEDURES

7.3.4.1 Visit 1 (Screening)

- 1) Written informed consent.
- 2) Assign subject number.

CLINICAL PROTOCOL

Date: July 26, 2022	Phase: Phase 3 Study	Protocol No.: GC-012
------------------------	-------------------------	-------------------------

- 3) Demographics, medical and surgical history, current ocular and systemic conditions, prescription medications, and medications known or suspected to lower IOP.
- 4) Measure best spectacle corrected visual acuity through manifest refraction (Snellen) in each eye.
- 5) Provide adequate and interpretable visual field using [REDACTED] (if not performed within the previous six months).
- 6) Conduct slit-lamp biomicroscopy (including crystalline lens).
- 7) Measure IOP (can be measured at any time) using the two-person methodology.
- 8) Pachymetry (ultrasonic).
- 9) Conduct a gonioscopic examination.
- 10) Conduct a dilated ophthalmoscopy/fundus examination.
- 11) Assess optic nerve abnormality (ophthalmoscopy).
- 12) Assess vertical C/D ratio.
- 13) Review screening inclusion and exclusion criteria. Do not continue screening any subject who does not meet the screening eligibility requirements

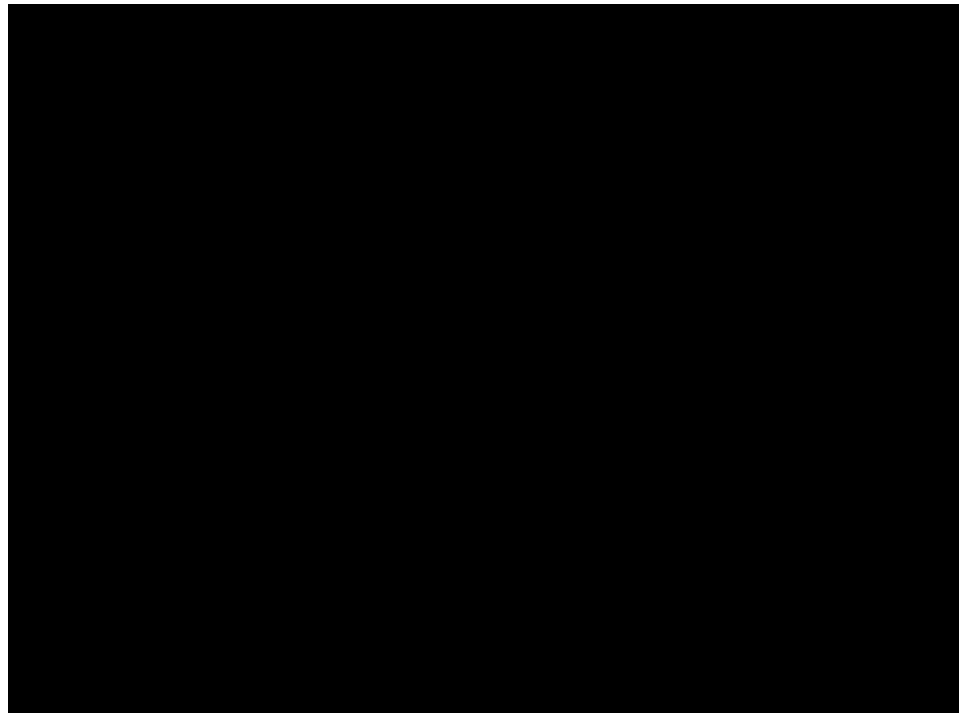

Remind the subject of the following:

- i. *Visit 2 (Baseline) is a day-long exam that begins before 8:00 AM and to plan accordingly*



CLINICAL PROTOCOL

Date: July 26, 2022	Phase: Phase 3 Study	Protocol No.: GC-012
------------------------	-------------------------	-------------------------

If the subject is ineligible for the study, complete the appropriate CRF.

7.3.4.2 Visit 2 (Baseline)

- 1) Confirm that an adequate medication washout was completed.
- 2) Update subject's medical history and concomitant medications.
- 3) Assess any adverse events.

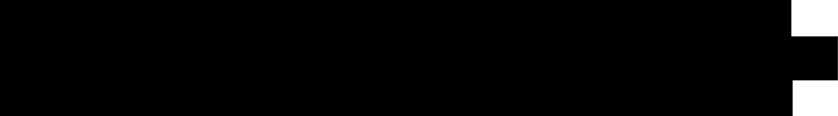
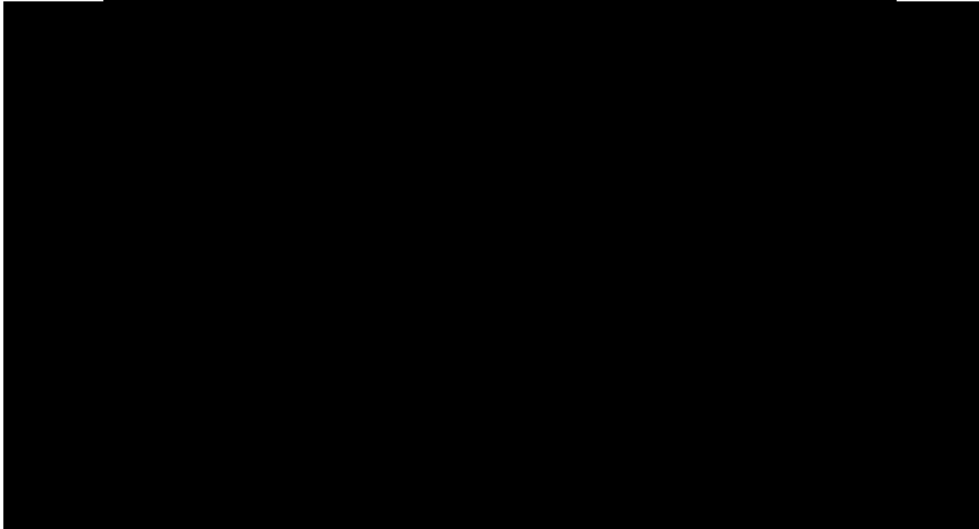
- 
- 4) Measure best spectacle corrected visual acuity through manifest refraction (ETDRS).
 - 5) Conduct slit-lamp biomicroscopy & ocular assessments (conjunctiva and iris).
 - 6) Specular microscopy photos will be captured at selected sites at any time during this visit (recommended prior to topical anesthetic).
 - 7) Measure diurnal IOP at 8:00 AM (\pm 30 minutes) using the two-person methodology.
 - 8) Measure diurnal IOP at 10:00 AM (\pm 30 minutes) using the two-person methodology.
 - 9) Measure diurnal IOP at 4:00 PM (\pm 30 minutes) using the two-person methodology.
 - 10) A pregnancy test (if applicable) may be administered at any time during this visit. Urine pregnancy test is acceptable.
 - 11) Verify eligibility against all study inclusion and exclusion criteria.
 - 12) Designate the qualifying eye as the study eye. If both eyes qualify, select the RIGHT eye.
- 
- 
- 

CLINICAL PROTOCOL

Date: July 26, 2022	Phase: Phase 3 Study	Protocol No.: GC-012
------------------------	-------------------------	-------------------------

If the subject is ineligible for the study, complete the appropriate CRF.

7.3.5 TREATMENT PROCEDURES

7.3.5.1 Visit 3 (Operative Day 0)

- 1) Assess any adverse events.
- 2) Prepare subject for surgery.
- 3) Administer an additional drop of antibiotic 30 minutes preoperatively.
- 4) Visually confirm Shaffer grade angle and target implant location.
- 5) Obtain a randomization assignment from online electronic data capture system. NOTE: This step should be done immediately prior to the operative procedure in order to ensure the randomization is successfully assigned.
- 6) Obtain the corresponding unique randomization kit to be used in surgery.
- 7) Administer anesthetic (general, retrobulbar, peribulbar or topical for implant subjects; topical for sham procedure subjects).
- 8) Perform surgery as per randomization assignment: implant either G2TR-[REDACTED] or G2TR-[REDACTED], OR perform sham procedure using syringe.
- 9) Record clinical data from the surgical procedure on the Operative Day 0 CRF, noting any intra-operative AEs and post-operative AEs.

Postoperatively:

- 10) Obtain the unique masked study medication kit to be used after surgery (topical study medication). Dispense the masked study medications to the subject, and instruct the subject to use one drop of the masked study medication in the study eye at approximately 8:00 PM that evening (7:00 PM to 9:00 PM).
- 11) Schedule the subject to return for Visit 4 (Day 1-2) to collect a standard IOP measurement at either 8:00 AM (\pm 30 minutes), 10:00 AM (\pm 30 minutes), OR 4:00 PM (\pm 30 minutes). [REDACTED]
[REDACTED]
[REDACTED]
Remind the subject to bring all study medications to the visit.
- 12) Dispense other postoperative medications and instruct the subject as follows:

CLINICAL PROTOCOL

Date: July 26, 2022	Phase: Phase 3 Study	Protocol No.: GC-012
------------------------	-------------------------	-------------------------

• [REDACTED]

7.3.5.2 Visit 4 (Day 1-2 Exam, 1-2 days postoperative)

- 1) For 8:00 AM IOP visits: Confirm that the subject has not instilled their 8:00 AM masked study medication.
- 2) Update subject's medical status and concomitant medications.
- 3) Assess any adverse events.
- 4) Assess subject dosing compliance.
- 5) Measure pinhole visual acuity (Snellen).
- 6) Conduct slit-lamp biomicroscopy.
- 7) Measure standard IOP at either 8:00 AM (\pm 30 minutes), 10:00 AM (\pm 30 minutes), OR 4:00 PM (\pm 30 minutes) and record the time using the two-person methodology.
- 8) For 8:00 AM IOP visits: [REDACTED]
- 9) Instruct the subject to instill the masked study drop at [REDACTED]
- 10) Schedule the subject to return for Visit 5 (Day 10). Remind the subject of the following:
 - i. *Visit 5 (Day 10) is a day-long exam that begins before 8:00 AM and to plan accordingly*
 - ii. *Instill the masked study medication the evening before Visit 5 (Day 10), but not on the morning of Visit 5 (Day 10)*
 - iii. *Bring all study medications to the visit.*

7.3.5.3 Visit 5 (Day 10 Exam, 10 \pm 3 days postoperative)

- 1) Confirm that the subject has not instilled their 8:00 AM masked study medication.
- 2) Update subject's medical status and concomitant medications.

CLINICAL PROTOCOL

Date: July 26, 2022	Phase: Phase 3 Study	Protocol No.: GC-012
------------------------	-------------------------	-------------------------

- 3) Assess any adverse events.
- 4) Assess subject dosing compliance.

- [REDACTED]
- 5) Measure pinhole visual acuity (Snellen).
 - 6) Conduct slit-lamp biomicroscopy & ocular assessments (conjunctiva and iris).
 - 7) Measure diurnal IOP at 8:00 AM (± 30 minutes) using the two-person methodology.
 - 8) Immediately after the 8:00 AM measurement, instill one drop of masked study medication.
 - 9) Conduct a gonioscopic examination.
 - 10) Measure diurnal IOP at 10:00 AM (± 30 minutes) using the two-person methodology.
 - 11) Measure diurnal IOP at 4:00 PM (± 30 minutes) using the two-person methodology.

- 12) [REDACTED]
- 13) Schedule the subject to return for Visit 6 (Week 4) to collect a standard IOP measurement at either 8:00 AM, 10:00 AM, OR 4:00 PM. If Visit 6 (Week 4) is scheduled for an 8:00 AM IOP measurement, instruct the subject to instill the masked study medication the evening before Visit 6 (Week 4), but not on the morning of Visit 6 (Week 4). Remind the subject to bring all study medications to the visit.

7.3.5.4 Visit 6 (Week 4 Exam, 28 \pm 3 day postoperative)

- 1) For 8:00 AM visits: Confirm that the subject has not instilled their 8:00 AM masked study medication.
- 2) Update subject's medical status and concomitant medications.
- 3) Assess any adverse events.
- 4) Assess subject dosing compliance.
- 5) Measure corrected visual acuity (ETDRS). [REDACTED]

CLINICAL PROTOCOL

Date: July 26, 2022	Phase: Phase 3 Study	Protocol No.: GC-012
------------------------	-------------------------	-------------------------

- 6) Conduct slit-lamp biomicroscopy & ocular assessments (conjunctiva and iris).
- 7) Measure standard IOP at either 8:00 AM (\pm 30 minutes), 10:00 AM (\pm 30 minutes), OR 4:00 PM (\pm 30 minutes) and record the time using the two-person methodology .
- 8) For 8:00 AM visits: Instill one drop of masked study medication immediately after the IOP measurement.
- 9) Conduct a gonioscopic examination.
- 10) [REDACTED]
- 11) Schedule the subject to return for Visit 7 (Week 6). Remind the subject of the following:
 - i. *Visit 7 (Week 6) is a day-long exam that begins before 8:00 AM and to plan accordingly.*
 - ii. *Instill the masked study medication the evening before Visit 7 (Week 6), but not on the morning of Visit 7 (Week 6).*
 - iii. *Bring all study medications to the visit.*

7.3.5.5 Visit 7 (Week 6 Exam, 42 \pm 5 days postoperative)

- 1) Confirm that the subject has not instilled their 8:00 AM masked study medication.
- 2) Update subject's medical status and concomitant medications.
- 3) Assess any adverse events.
- 4) Assess subject dosing compliance.

- [REDACTED] :
- 5) Measure corrected visual acuity [REDACTED]. [REDACTED]
[REDACTED]
 - 6) Conduct slit-lamp biomicroscopy & ocular assessments (conjunctiva and iris).
 - 7) Measure diurnal IOP at 8:00 AM (within \pm 30 minutes) using the two-person methodology.
 - 8) Immediately after the 8:00 AM measurement, instill one drop of masked study medication.
 - 9) Conduct a gonioscopic examination.

CLINICAL PROTOCOL

Date: July 26, 2022	Phase: Phase 3 Study	Protocol No.: GC-012
------------------------	-------------------------	-------------------------

- 10) Measure diurnal IOP at 10:00 AM (\pm 30 minutes) using the two-person methodology.
- 11) Measure diurnal IOP at 4:00 PM (\pm 30 minutes) using the two-person methodology.
- 12) Instruct the subject to instill the masked study drop at approximately 8:00 PM (7:00 PM to 9:00 PM) later that evening
[REDACTED]
- 13) Schedule the subject to return for Visit 8 (Month 3). Remind the subject of the following:
 - i. *Visit 8 (Month 3) is a day-long exam that begins before 8:00 AM and to plan accordingly.*
 - ii. *Instill the masked study medication the evening before Visit 8 (Month 3), but not on the morning of Visit 8 (Month 3).*
 - iii. *Bring all study medications to the visit.*

7.3.5.6 Visit 8 (Month 3 Exam, 91 ± 14 days postoperative)

- 1) Confirm that the subject has not instilled their 8:00 AM masked study medication.
- 2) Update subject's medical status and concomitant medications.
- 3) Assess any adverse events.
- 4) Assess subject dosing compliance.
[REDACTED]
- 5) Measure corrected visual acuity [REDACTED]
[REDACTED]
- 6) Conduct slit-lamp biomicroscopy & ocular assessments (conjunctiva and iris).
- 7) Measure diurnal IOP at 8:00 AM (within \pm 30 minutes) using the two-person methodology .
- 8) Immediately after the 8:00 AM measurement, instill one drop of masked study medication.
- 9) Conduct a gonioscopic examination.
- 10) Assess optic nerve abnormality (ophthalmoscopy).
- 11) [REDACTED]
[REDACTED]

CLINICAL PROTOCOL

Date: July 26, 2022	Phase: Phase 3 Study	Protocol No.: GC-012
------------------------	-------------------------	-------------------------

- 12) Measure diurnal IOP at 10:00 AM (\pm 30 minutes) using the two-person methodology.
- 12) Measure diurnal IOP at 4:00 PM (\pm 30 minutes) using the two-person methodology.
- 13) Dispense replacement masked study medication to the subject and

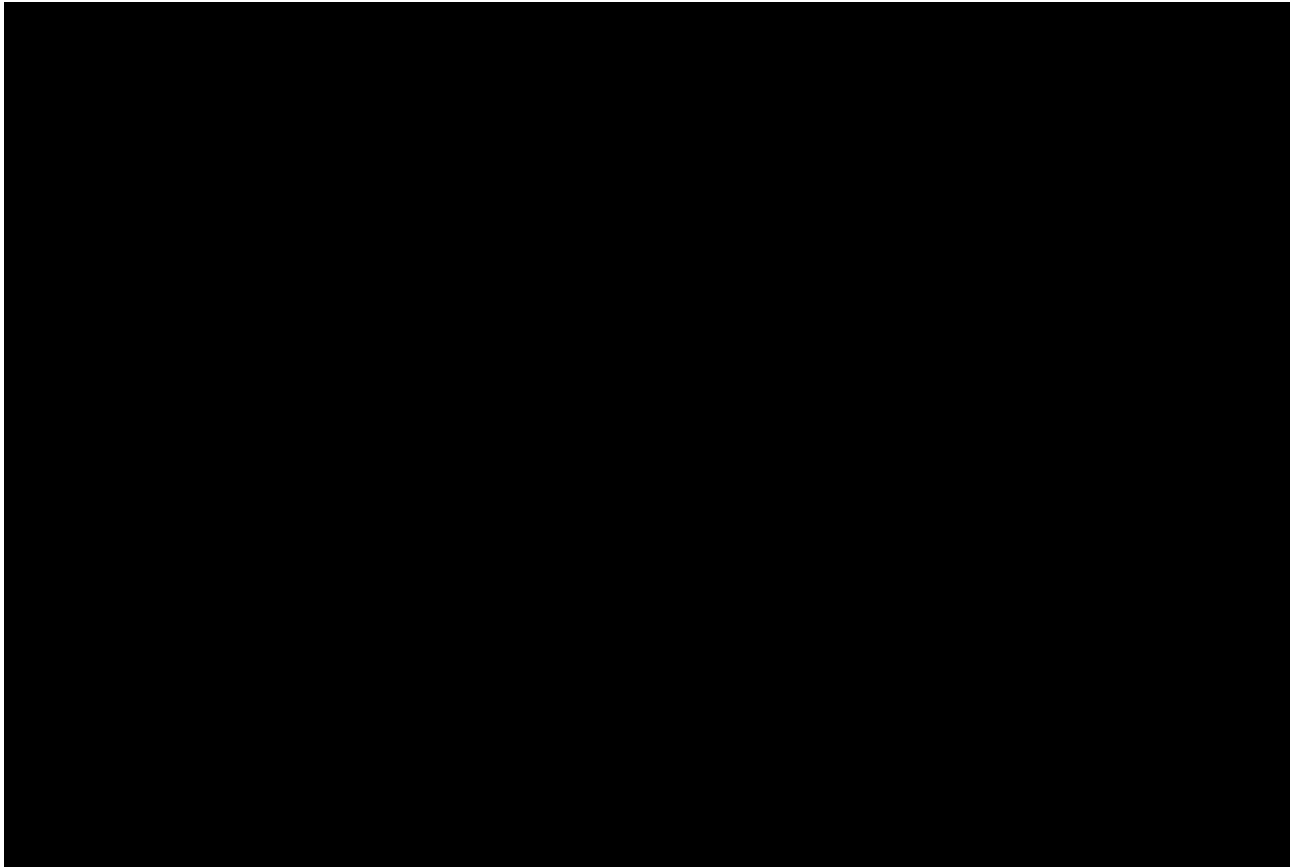
- 14) Schedule the subject to return for Visit 9 (Month 6) to collect a standard IOP measurement at either 8:00 AM, 10:00 AM, OR 4:00 PM. If Visit 9 (Month 6) is scheduled for an 8:00 AM IOP measurement, instruct the subject to instill the masked study medication the evening before Visit 9 (Month 6), but not on the morning of Visit 9 (Month 6). Remind the subject to bring all study medications to the visit.

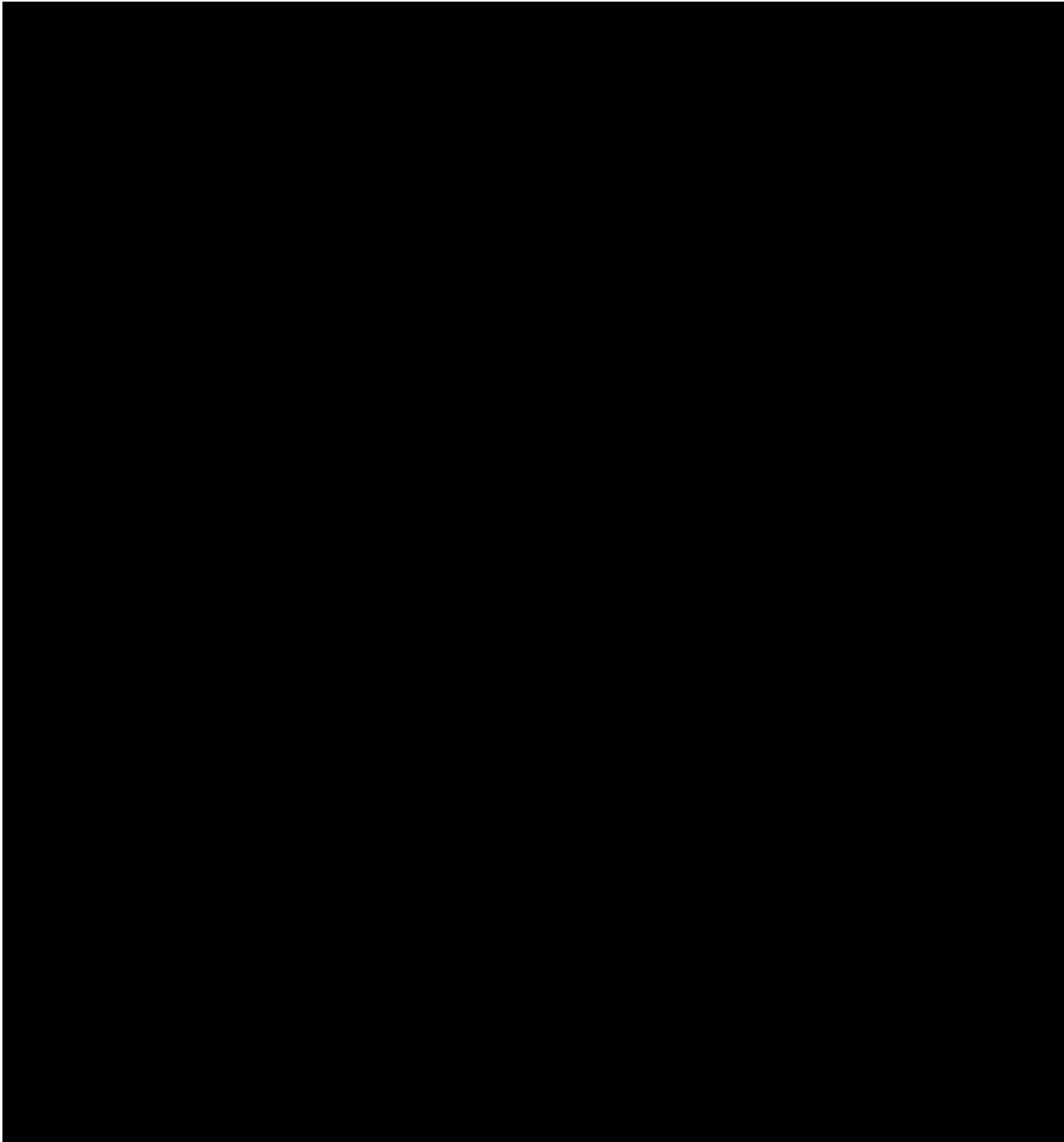

CLINICAL PROTOCOL

Date: July 26, 2022	Phase: Phase 3 Study	Protocol No.: GC-012
------------------------	-------------------------	-------------------------



CLINICAL PROTOCOL

Date: July 26, 2022	Phase: Phase 3 Study	Protocol No.: GC-012
------------------------	-------------------------	-------------------------

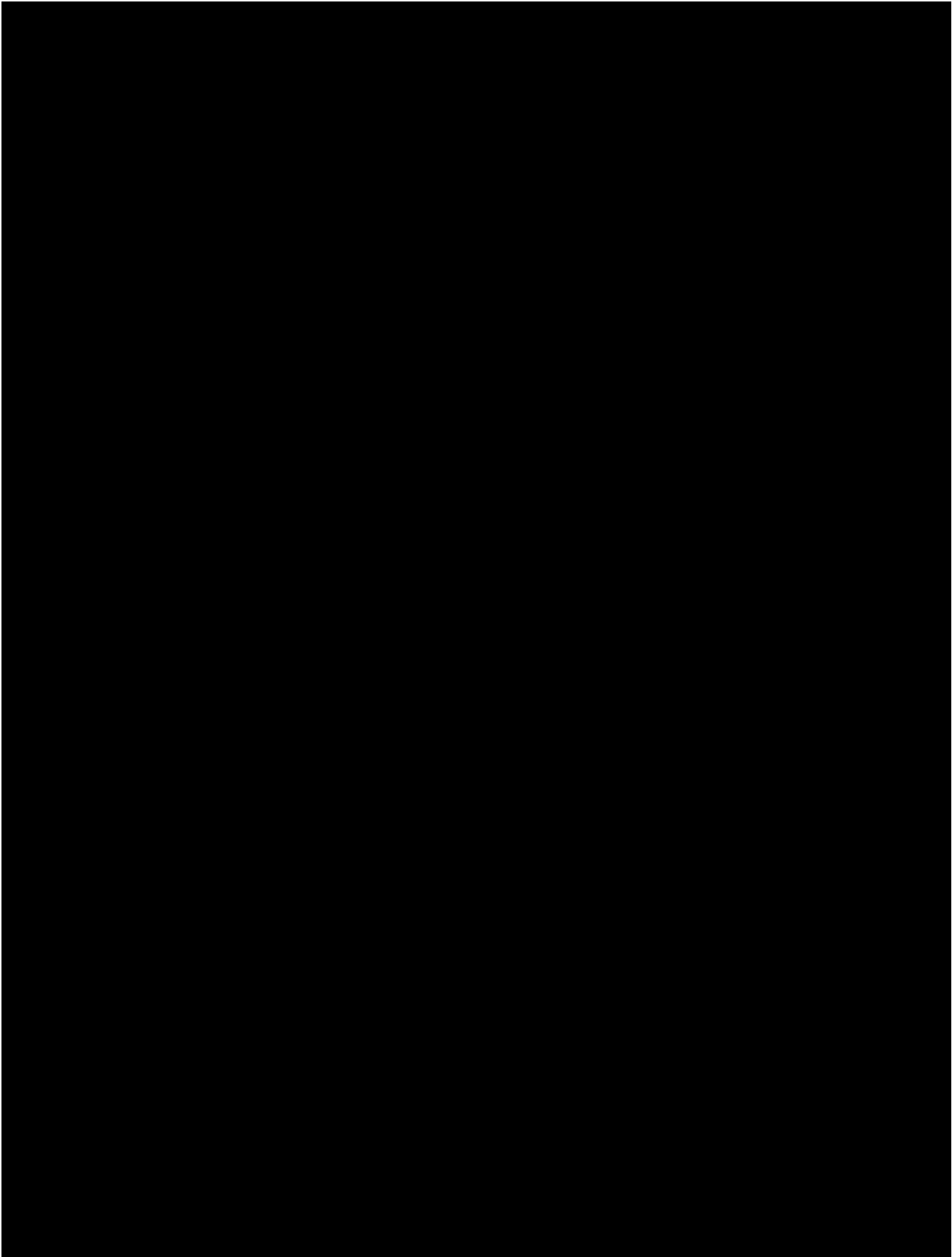

CLINICAL PROTOCOL

Date: July 26, 2022	Phase: Phase 3 Study	Protocol No.: GC-012
------------------------	-------------------------	-------------------------

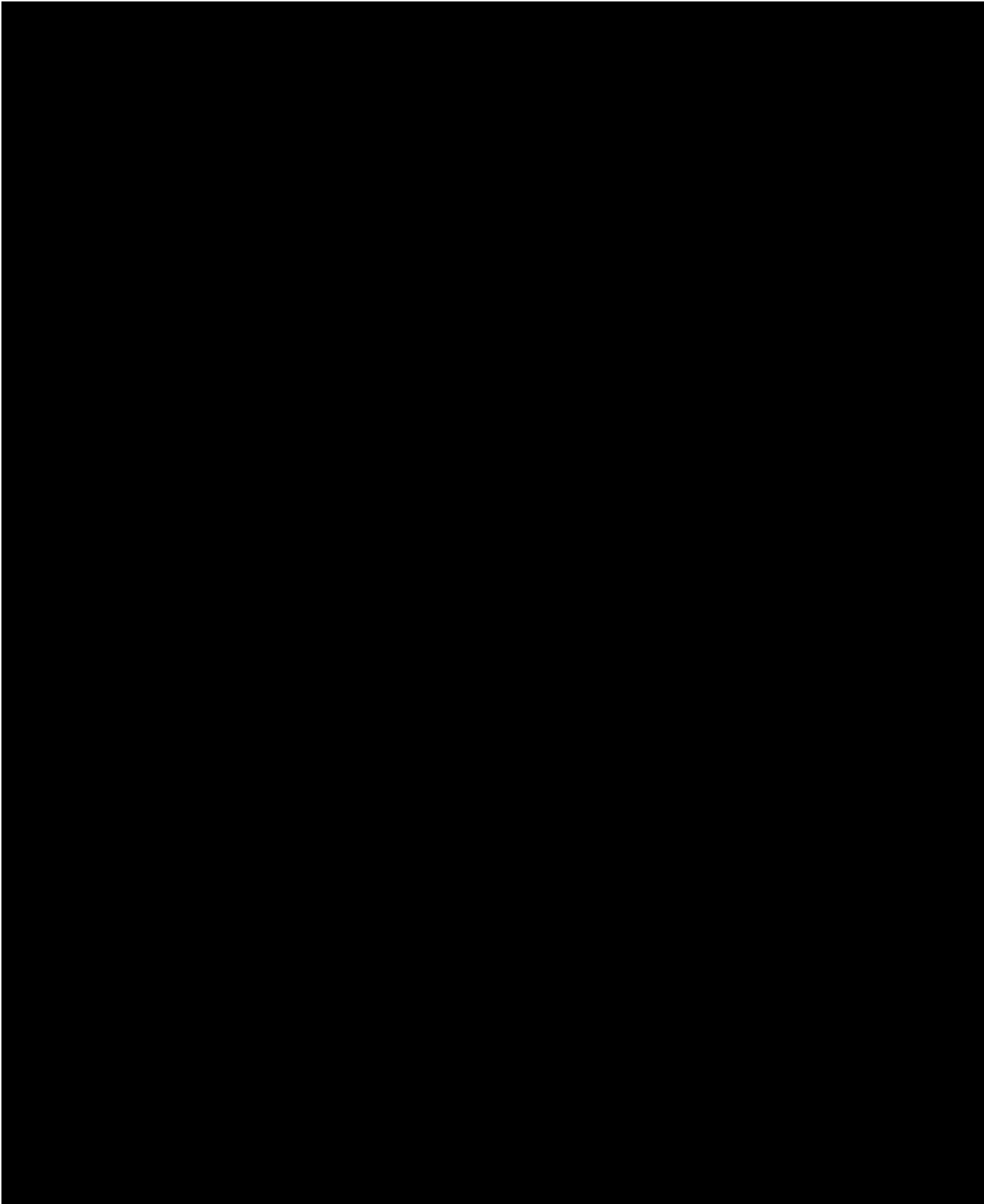

CLINICAL PROTOCOL

Date: July 26, 2022	Phase: Phase 3 Study	Protocol No.: GC-012
------------------------	-------------------------	-------------------------

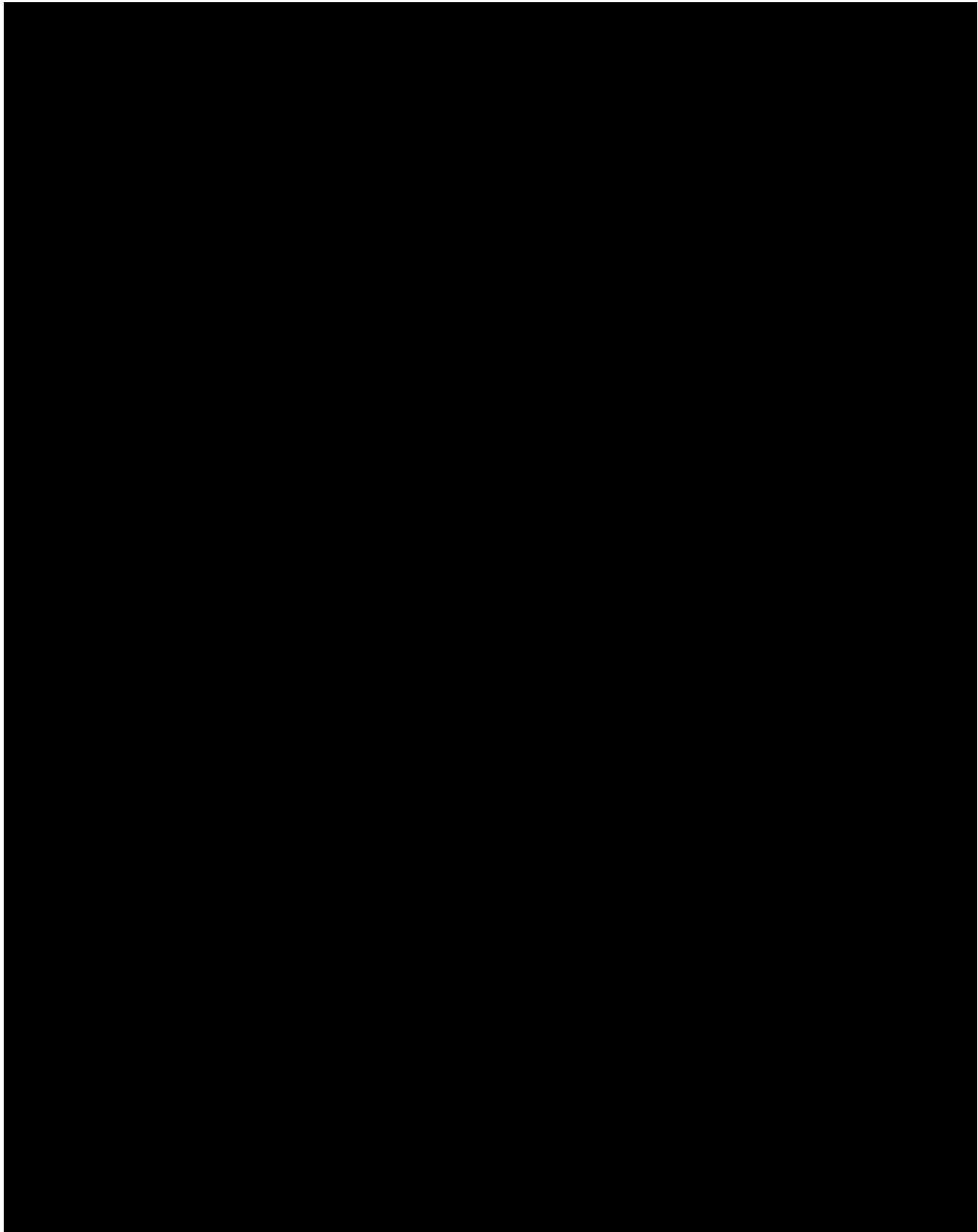

CLINICAL PROTOCOL

Date: July 26, 2022	Phase: Phase 3 Study	Protocol No.: GC-012
------------------------	-------------------------	-------------------------

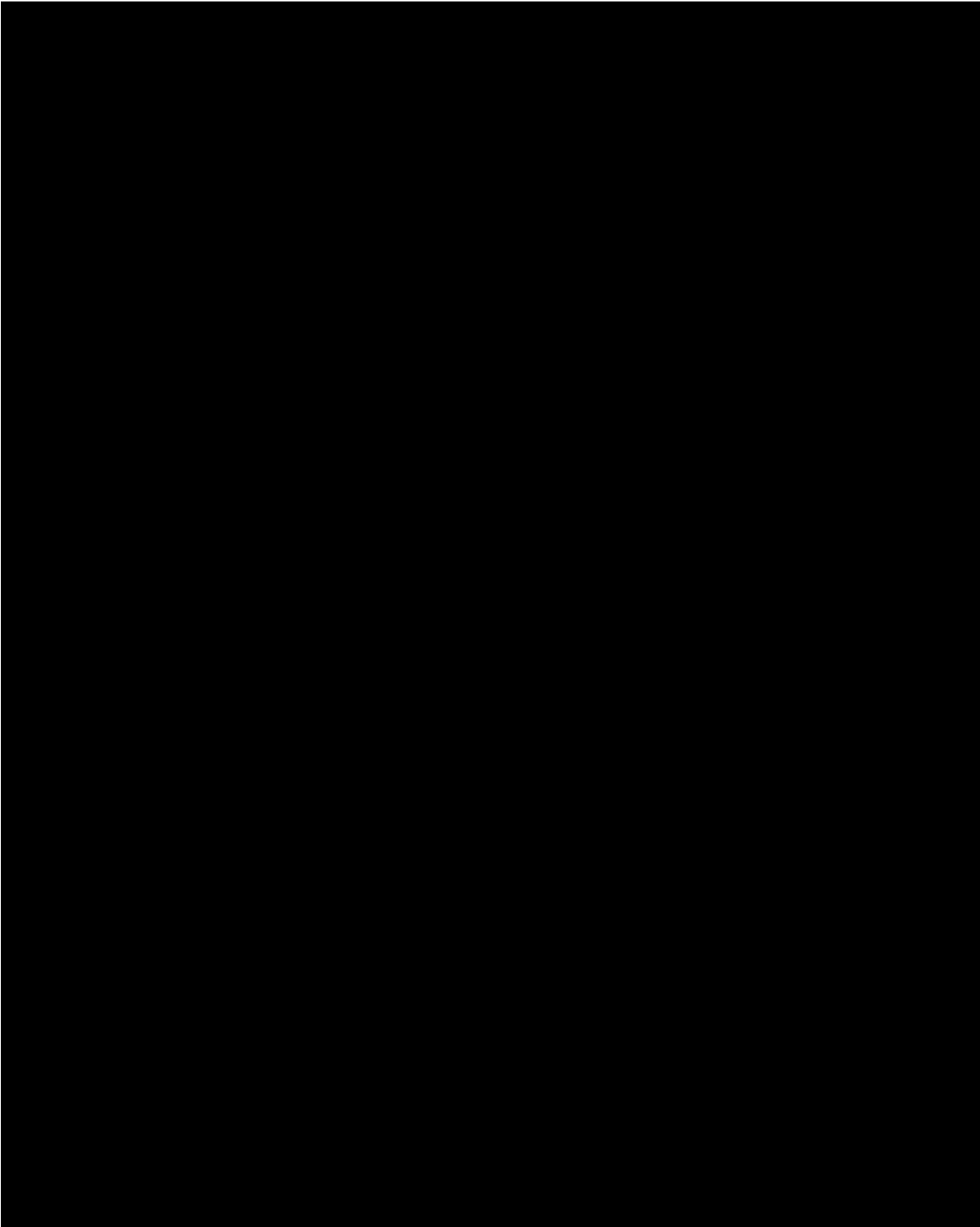

CLINICAL PROTOCOL

Date: July 26, 2022	Phase: Phase 3 Study	Protocol No.: GC-012
------------------------	-------------------------	-------------------------

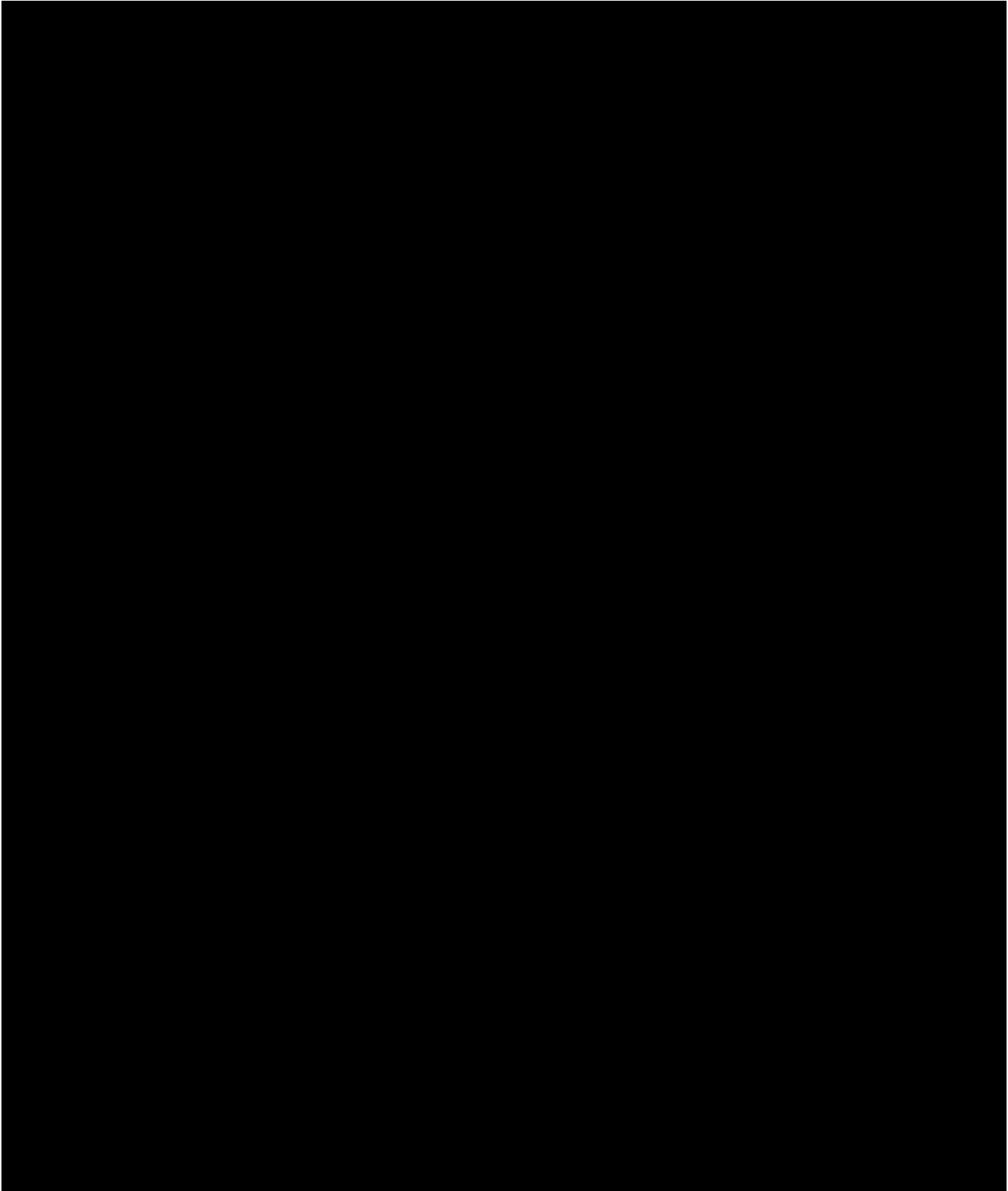

CLINICAL PROTOCOL

Date: July 26, 2022	Phase: Phase 3 Study	Protocol No.: GC-012
------------------------	-------------------------	-------------------------

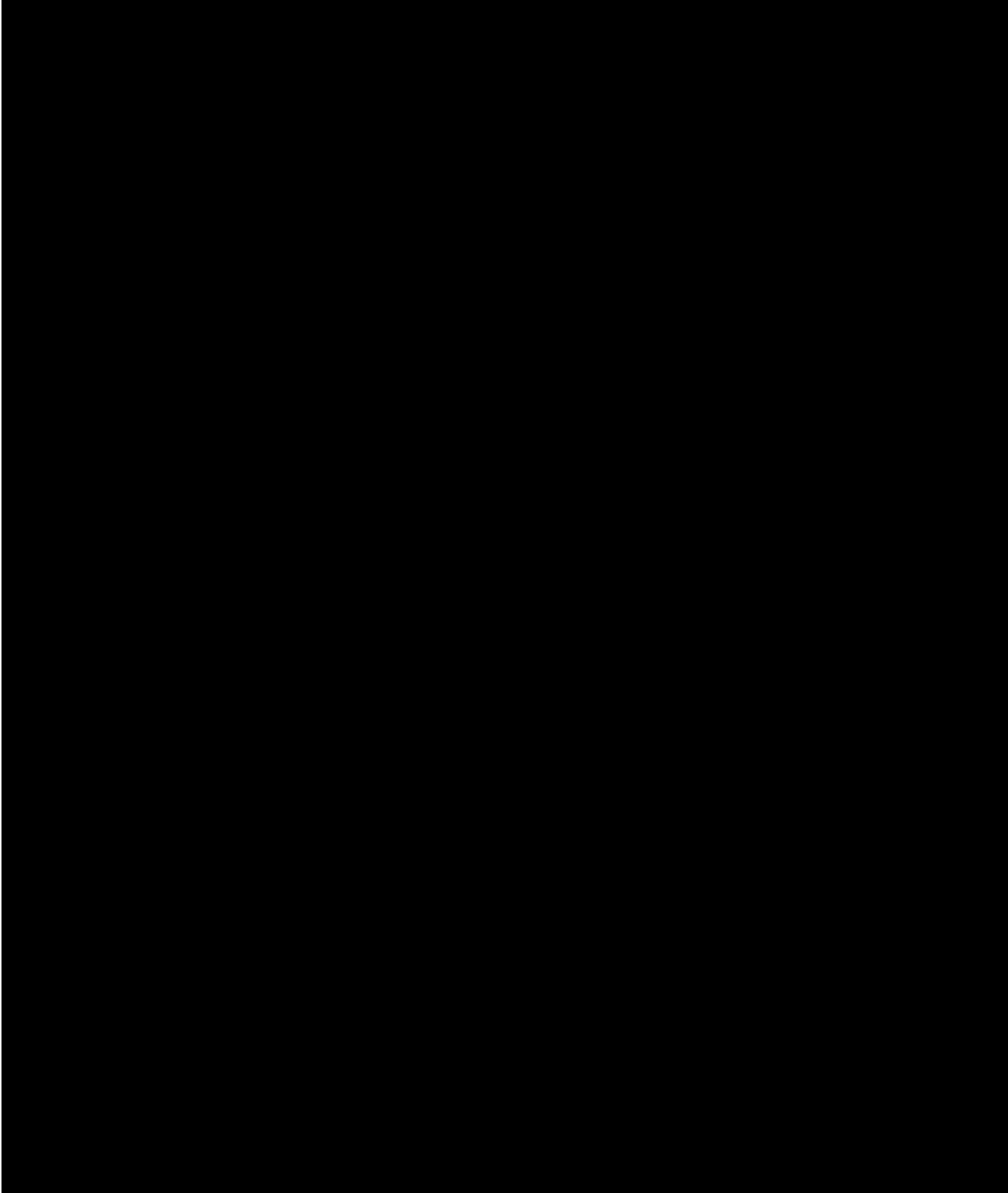

CLINICAL PROTOCOL

Date: July 26, 2022	Phase: Phase 3 Study	Protocol No.: GC-012
------------------------	-------------------------	-------------------------

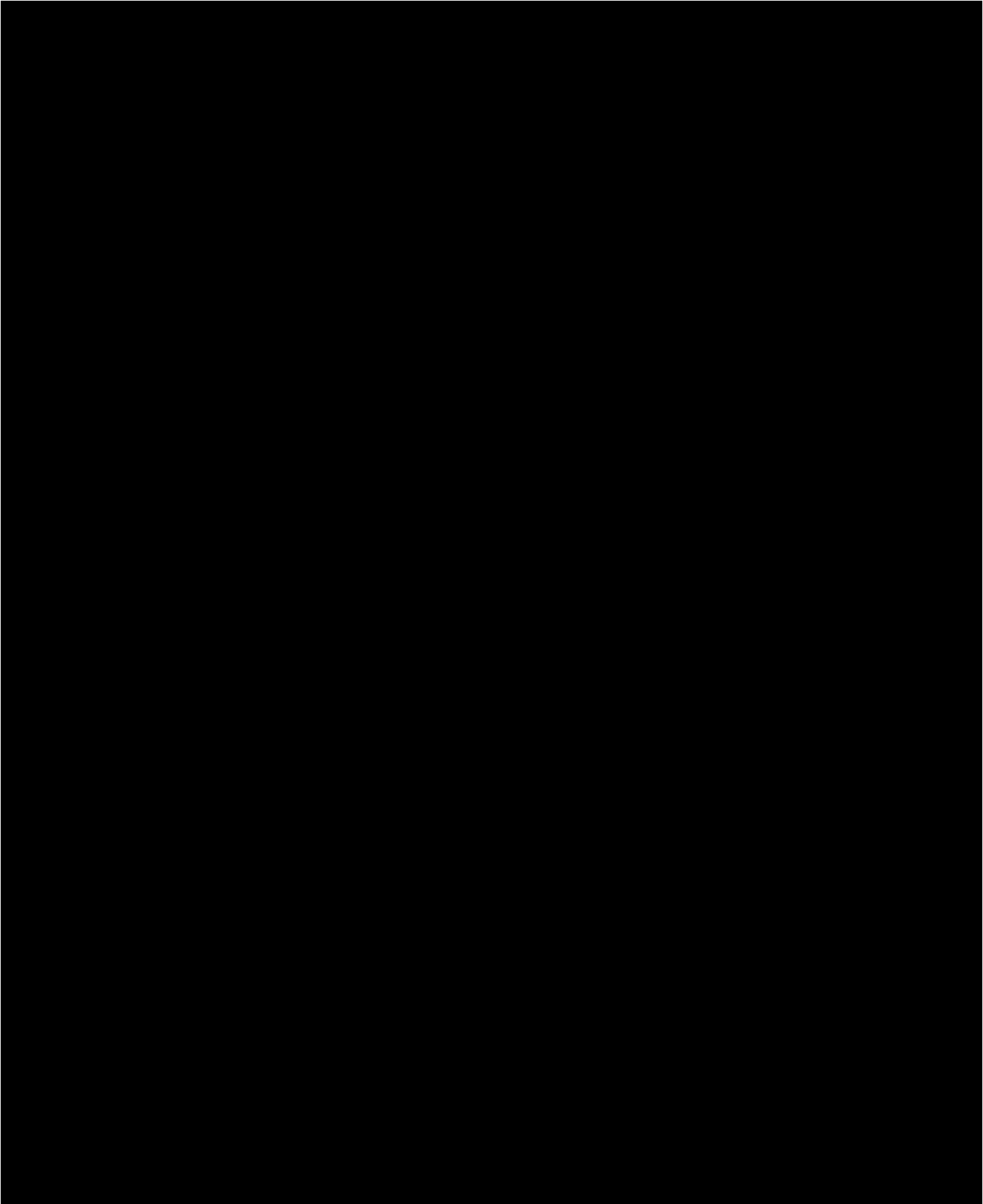

CLINICAL PROTOCOL

Date: July 26, 2022	Phase: Phase 3 Study	Protocol No.: GC-012
------------------------	-------------------------	-------------------------

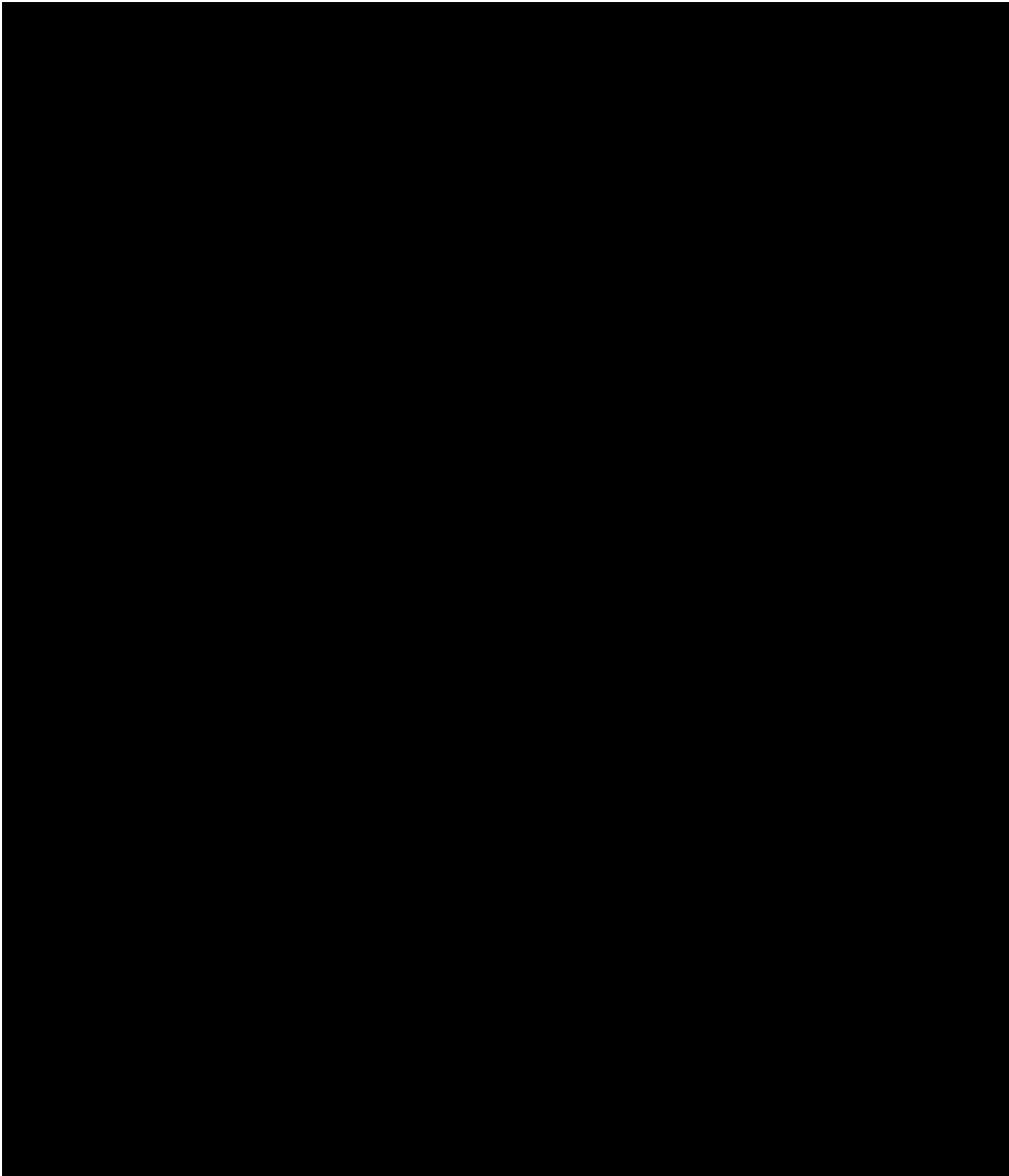

CLINICAL PROTOCOL

Date: July 26, 2022	Phase: Phase 3 Study	Protocol No.: GC-012
------------------------	-------------------------	-------------------------

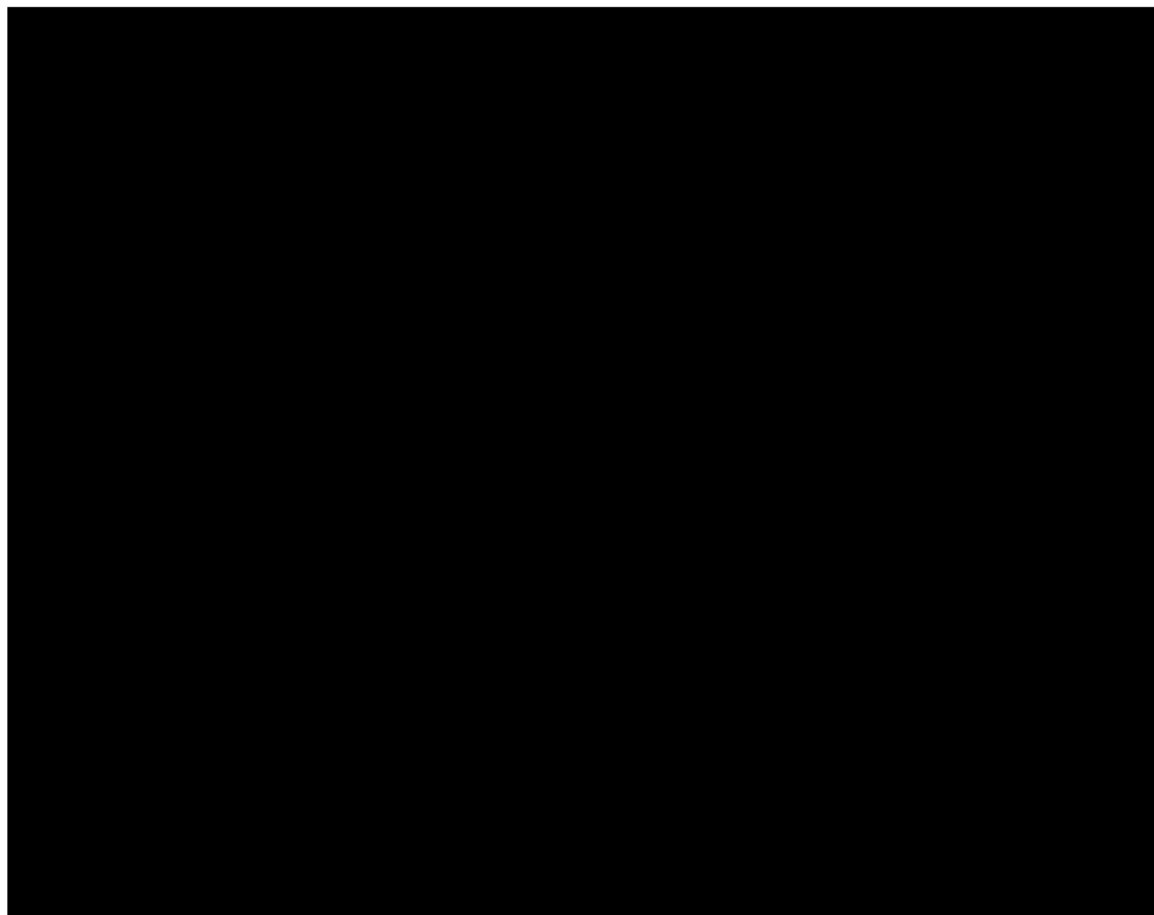

7.4 Concomitant Therapies

7.4.1 MEDICATIONS OR TREATMENTS

Therapy considered necessary for the subject's welfare that will not interfere with the evaluation of the study medication may be given at the discretion of the investigator. Whenever [REDACTED] should be administered in dosages that remain constant throughout the study period.

7.4.2 USE OF CONTACT LENSES

Contact lens wear is allowed in this study. [REDACTED] before inserting their contact lenses after instillation of study medication.

7.5 Post-Treatment Management of IOP and Rescue Medications

The following instructions are the minimum level of treatment the investigator will perform on a study subject. Both groups (treatment and control) should be treated consistently unless otherwise noted in this section. Treatment

CLINICAL PROTOCOL

Date: July 26, 2022	Phase: Phase 3 Study	Protocol No.: GC-012
------------------------	-------------------------	-------------------------

considered necessary for the subject's welfare can be implemented at any time during the study at the investigator's discretion. [REDACTED]

If an IOP rise is observed in an implant subject, a [REDACTED]

7.5.1 WITHIN TWO DAYS POST-TREATMENT: IOP INCREASE TO ≥ 30 mmHg

Subjects in a Travoprost Intraocular Implant Group

[REDACTED] ed at any time during the study at the investigator's discretion.

7.5.2 WITHIN TWO DAYS POST [REDACTED]

7.5.3 AT ANYTIME POST OPERATIVE: [REDACTED]

I [REDACTED]

7.5.4 [REDACTED]

CLINICAL PROTOCOL

Date: July 26, 2022	Phase: Phase 3 Study	Protocol No.: GC-012
------------------------	-------------------------	-------------------------



CLINICAL PROTOCOL

Date: July 26, 2022	Phase: Phase 3 Study	Protocol No.: GC-012
------------------------	-------------------------	-------------------------

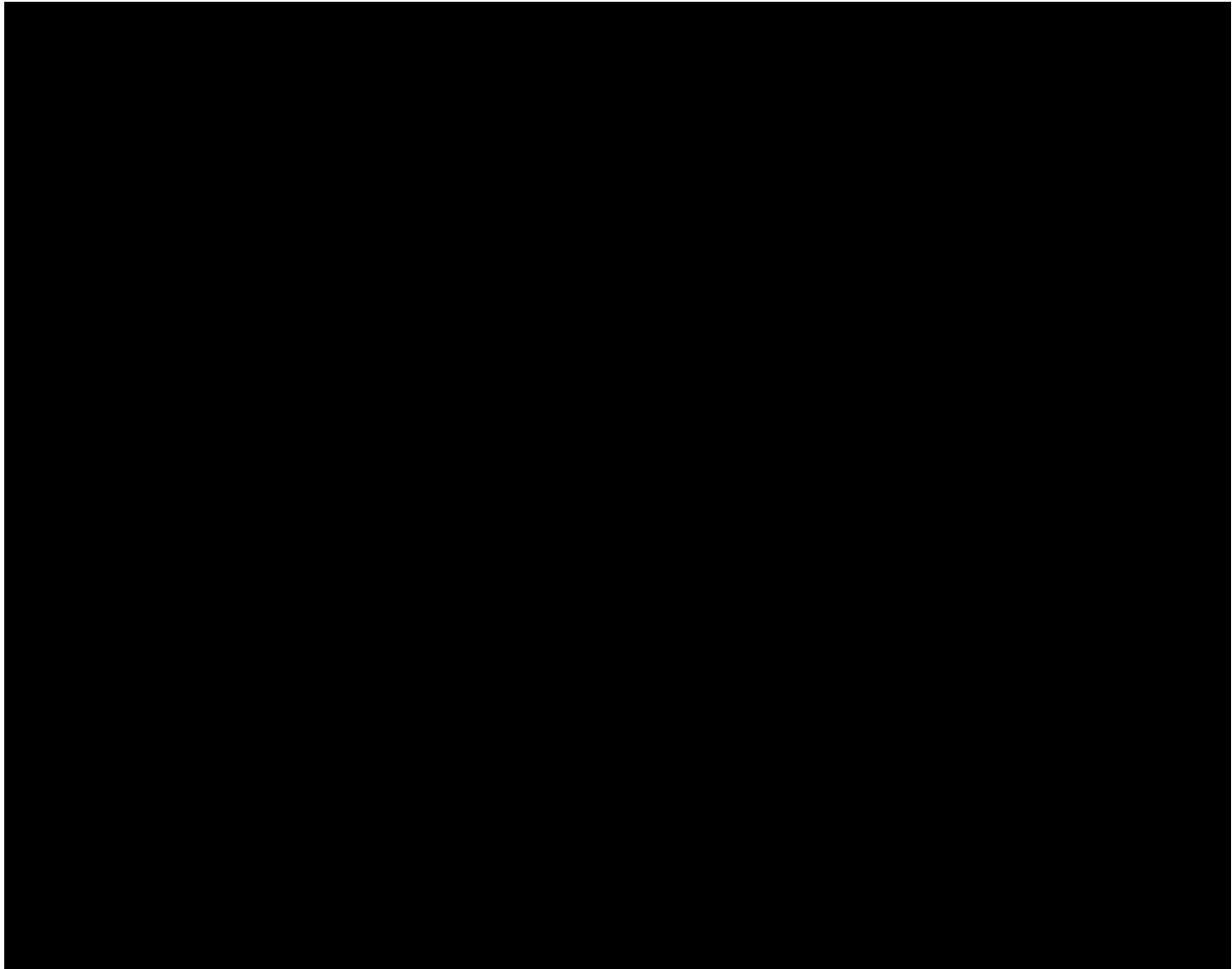

CLINICAL PROTOCOL

Date: July 26, 2022	Phase: Phase 3 Study	Protocol No.: GC-012
------------------------	-------------------------	-------------------------

8 EXTENT OF EXPOSURE AND TREATMENT COMPLIANCE

Following the procedure, all subjects will be provided with masked study medication for the duration of the study and instructed to instill one drop in the designated study eye twice daily at approximately 8:00 AM (7:00 AM to 9:00 AM) and 8:00 PM (7:00 AM to 9:00 AM). The first dose will be instilled the evening of Visit 3 (Operative Day 0).

- [REDACTED]

To ensure compliance with the treatment regimen, the 8:00 AM morning dose of the study medications will be instilled in the office by the investigator or his/her designee at Visit 4 through [REDACTED]. Subjects will receive instructions regarding the proper instillation of study medication and the dosing regimen.

9 STATISTICAL ANALYSES

[REDACTED]

9.1 Sample Size

[REDACTED]

CLINICAL PROTOCOL

Date: July 26, 2022	Phase: Phase 3 Study	Protocol No.: GC-012
------------------------	-------------------------	-------------------------

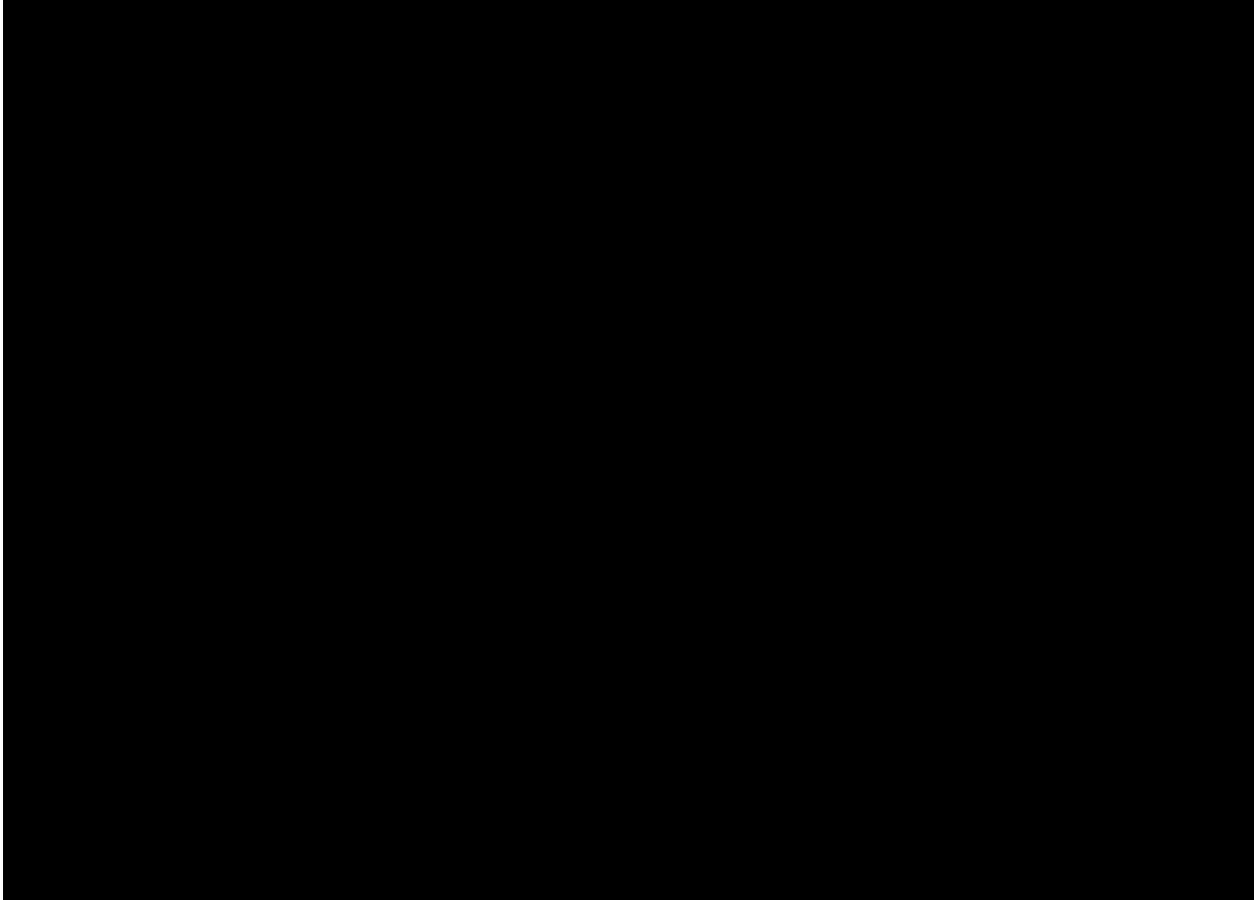

9.2 Analysis Populations

9.2.1 SAFETY POPULATION (SP)

The safety analysis population will contain all subjects who are randomized and receive any level of treatment. Subjects will be grouped according to their actual treatment received, not according to their randomization assignment (as randomized).

9.2.2 INTENT-TO-TREAT (ITT) POPULATION

This subset includes all subjects who are randomized. All baseline characteristics will be summarized based on ITT. Subjects in the ITT will be analyzed according to original treatment assignment, regardless of actual treatment received. The primary analyses will be based on this ITT population.

9.2.3 PER-PROTOCOL (PP) POPULATION

The Per Protocol Population is a subset of ITT. It includes all the ITT subjects who received the treatment and medication drops based on the

CLINICAL PROTOCOL

Date: July 26, 2022	Phase: Phase 3 Study	Protocol No.: GC-012
------------------------	-------------------------	-------------------------

randomization schedule and do not have the major protocol deviations likely to impact the primary efficacy endpoints. [REDACTED]

9.3 General Statistical Methods

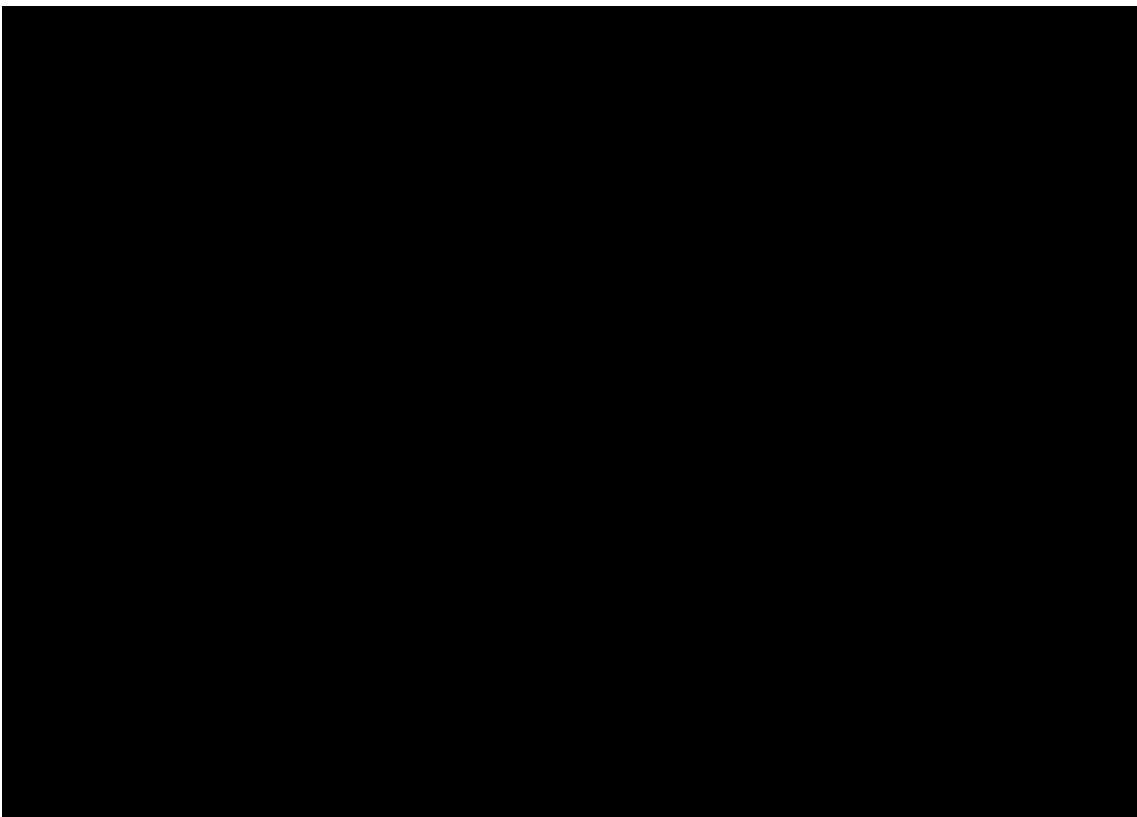

9.4 Safety Analyses

No formal statistical testing will be conducted for the safety analyses. No imputation will be performed for the missing values. All summaries will be based on the available data of the safety population.

Descriptive statistics will be calculated as described in [Section 9.3](#) at each visit for the 3 treatment groups separately. For each reported adverse event in each treatment group, the percentage of eyes will be reported. The sections below describe specific data handling for adverse events, and best spectacle corrected visual acuity (BSCVA).

Other safety outcomes such as slit lamp examination, intraocular pressure, dilated fundus examination, and endothelial cell count (from specular microscopy at selected sites) will be summarized descriptively at each visit for the Safety Population. Line listings for abnormal findings for individual eyes

CLINICAL PROTOCOL

Date: July 26, 2022	Phase: Phase 3 Study	Protocol No.: GC-012
------------------------	-------------------------	-------------------------

may be provided. A line listing of non-ocular serious adverse events will be provided by subject.

9.4.1 ADVERSE EVENTS

Treatment Emergent Adverse Events (TEAE) are defined as those AEs that occurred after the initial treatment at Visit 3 (Operative Day 0). Verbatim terms reported by the study sites will be coded using the Medical Dictionary for Regulatory Activities (MedDRA) nomenclature. TEAEs will be summarized for each preferred term by treatment group. Adverse event listings will be displayed by treatment group.

AEs that occur on the date of the procedure are classified on the case report form as either intra-operative or post-operative. Post-operative AEs are considered to be TEAEs. Intra-operative AEs will be tabulated separately.

A line listing of serious adverse events will be provided by subject.

9.4.2 BEST SPECTACLE CORRECTED VISUAL ACUITY (BSCVA)

The number of [REDACTED] will be summarized descriptively at each visit using the statistics for the continuous variables described in [Section 9.3](#) for each of the three treatment groups. The change in [REDACTED] from Visit 2 (Baseline) to the follow-up visits will be calculated for each subject. The change in the number of [REDACTED] will be summarized using statistics for continuous variables.

9.4.3 OTHER SAFETY MEASURES

Details for analyses of other safety measures including slit lamp examination and dilated fundus examination will be provided in the SAP.

9.5 Efficacy Endpoints

The primary efficacy measure in this study is IOP. Diurnal IOP (measured at 8:00 AM, 10:00 AM, AND 4:00 PM) is evaluated at Baseline, Day 10, Week 6, and Months 3, [REDACTED]. Standard IOP (measured at 8:00 AM, 10:00 AM, OR 4:00 PM) is evaluated at Week 4 and [REDACTED]

9.5.1 PRIMARY EFFICACY ENDPOINT

The primary efficacy endpoint is mean change from baseline IOP in the study eye at 8AM and 10AM at each of the Day 10, Week 6, and Month 3 visits (6 timepoints).

9.5.2 PRIMARY EFFICACY HYPOTHESES

CLINICAL PROTOCOL

Date: July 26, 2022	Phase: Phase 3 Study	Protocol No.: GC-012
------------------------	-------------------------	-------------------------

The primary analyses will compare each of the implant treatment arms to the control treatment arm with respect to mean change from baseline IOP at each of the 6 timepoints (8:00 AM \pm 30 minutes and 10:00 AM \pm 30 minutes at each of the Visit 5 (Day 10), Visit 7 (Week 6), and Visit 8 (Month 3) follow-up visits). For either the G2TR-1 or the G2TR-1 elution rate,

[REDACTED]

[REDACTED]

[REDACTED]

[REDACTED]

[REDACTED]

9.5.3 PRIMARY EFFICACY ANALYSES

[REDACTED]

Date: July 26, 2022	Phase: Phase 3 Study	Protocol No.: GC-012
------------------------	-------------------------	-------------------------

9.5.4 ANALYSIS OF KEY SECONDARY EFFICACY ENDPOINTS

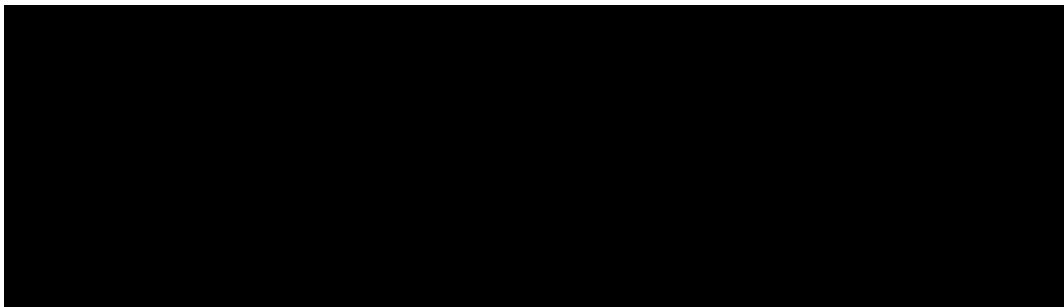

9.5.5 SENSITIVITY ANALYSES

Various sensitivity analyses will be performed, as specified in the statistical analysis plan, to determine robustness of results to underlying assumptions of missing data and data after intercurrent events.

9.5.6 SUBGROUP ANALYSES

Subgroup analyses will be performed, as specified in the statistical analysis plan, to investigate consistency of results across identified subgroups.

9.5.7 OTHER EFFICACY ANALYSES

The same analyses as described above for primary ([Section 9.5.3](#)) and secondary ([Section 9.5.4](#)) efficacy will be performed for IOP evaluations at



9.6 Interim Analyses

No interim analyses are planned.

10 ADVERSE EVENTS

An Adverse Event (AE) is defined as any untoward and unintended medical occurrence (e.g., sign, symptom, disease, syndrome, intercurrent illness) that occurs in a study subject, regardless of the suspected cause during the study. Adverse events will be clearly documented on the study source document and monitored throughout the course of the study.

Events occurring after signing the informed consent but prior to the implant or sham procedure should be documented in the medical history. Events

CLINICAL PROTOCOL

Date: July 26, 2022	Phase: Phase 3 Study	Protocol No.: GC-012
------------------------	-------------------------	-------------------------

observed during or after the implant or sham procedure until the final study visit, are to be recorded as AEs.

Any clinically significant change in a subject's condition after receiving any of the study treatments, regardless of causality, is to be considered an adverse event, unless the change is determined to be a continuation of a pre-existing condition that is documented in the subject's medical history. If an adverse event occurs, an AE form must be completed.

An AE includes any of the following:

- An exacerbation or an unexpected increase in frequency or intensity of a pre-existing condition, including intermittent or episodic conditions
- New conditions or illnesses detected or diagnosed after the implant or sham procedure
- A suspected interaction with any of the study treatments
- Signs, symptoms, or the clinical sequelae of a suspected overdose of either any of the study treatments or a concomitant medication
- Any clinically significant laboratory finding that was not present prior to receiving any of the study treatments

An AE does NOT include any of the following:

- Anticipated day-to-day fluctuations of any pre-existing conditions, including the disease under study (OAG and OHT).
- Medical or surgical procedure, (e.g., colonoscopy or hernia repair). The condition that led to the procedure may be an AE, if not present in medical history.
- Hospitalizations where an untoward medical occurrence did not occur (social or convenience admission to the hospital).
- Pre-existing conditions or diseases that were present before receiving any of the study treatments that do not worsen or that are chronic but stable
- Changes in a chronic condition or disease that are consistent with natural disease progression. (These medical conditions should be adequately documented).
- Lack of efficacy of the study treatment for the condition being investigated.

CLINICAL PROTOCOL

Date: July 26, 2022	Phase: Phase 3 Study	Protocol No.: GC-012
------------------------	-------------------------	-------------------------

AEs will be graded on a 3-point scale and reported in detail as indicated on the CRF:

- Mild: easily tolerated, causing minimal discomfort and not interfering with normal everyday activities
- Moderate: sufficiently discomforting to interfere with normal everyday activities
- Severe: incapacitating and/or preventing normal everyday activities

The relationship of each AE to study treatment should be determined by the investigator using the following explanations:

- Definitely Unrelated: the event is clearly related to other factors such as the subject's clinical state, therapeutic interventions, or concomitant medications administered to the subject
- Unlikely Related: the event is most likely produced by other factors such as the subject's clinical state, therapeutic interventions, or concomitant medications administered to the subject; and does not follow a known response pattern to the study medication
- Possibly Related: the event follows a reasonable temporal sequence from the time of drug administration; and/or follows a known response pattern to the study medication; but could have been produced by other factors such as the subject's clinical state, therapeutic interventions, or concomitant medications administered to the subject
- Probably Related: the event follows a reasonable temporal sequence from the time of drug administration; and/or follows a known response pattern to the study medication; and is not likely to have been produced by other factors such as the subject's clinical state, therapeutic interventions, or concomitant medications administered to the subject
- Definitely Related: the event follows a reasonable temporal sequence from the time of drug administration; and follows a known response pattern to the study medication; and cannot be reasonably explained by other factors such as the subject's clinical state, therapeutic interventions, or concomitant medications administered to the subject

CLINICAL PROTOCOL

Date: July 26, 2022	Phase: Phase 3 Study	Protocol No.: GC-012
------------------------	-------------------------	-------------------------

10.1 Serious Adverse Event

Serious adverse events are defined as any findings that suggest a significant hazard, contraindication, side effect, or precaution. Any adverse event is considered a serious adverse event if it results in any of the following outcomes:

- Death
- Life- or sight-threatening
- Required admission to the hospital or prolongation of an existing hospitalization (emergency room visits that do not result in admission to the hospital should be evaluated for one of the other serious outcomes)
- A persistent or significant disability/incapacity
- A congenital anomaly/birth defect

The terms “mild,” “moderate,” and “severe” are measures of intensity; thus a severe AE is not necessarily serious. For example, nausea of several hours duration may be rated as severe, but may not be clinically serious.

Important medical events that may not result in death, be life-threatening, or require admission to the hospital may be considered a serious adverse drug experience when, based upon appropriate medical judgment, they may jeopardize the subject and may require medical or surgical intervention to prevent one of the outcomes listed above. A life-threatening event is any event that places the subject at substantial risk of death from the event as it occurred; it does not refer to an event that hypothetically might have caused death if it were more severe. A sight-threatening event is any event that places the subject at risk of permanently losing vision in either eye as a direct result of the event.

Serious adverse events must be reported to Glaukos immediately (preferably within 24 hours of knowledge of the event).

Email: [REDACTED]

When new significant information (including the outcome of the event) is obtained, the investigator should inform Glaukos as soon as possible. Depending on the nature of the AE, Glaukos may request copies of the ophthalmic and medical records of the subject. If the subject was hospitalized for a study-treatment related serious adverse event, a copy of the discharge summary must be forwarded to Glaukos as soon as possible.

10.2 Unexpected Adverse Event

An adverse event is considered “unexpected” if it is not listed in the investigator brochure or is not listed at the specificity or severity that has been

CLINICAL PROTOCOL

Date: July 26, 2022	Phase: Phase 3 Study	Protocol No.: GC-012
------------------------	-------------------------	-------------------------

observed, or is not consistent with the risk information described in the general investigational plan or protocol.

Unexpected adverse events must be reported to Glaukos immediately (preferably within 24 hours of knowledge of the event).

Email: [REDACTED]

When new significant information (including the outcome of the event) is obtained, the investigator should inform Glaukos as soon as possible. Depending on the nature of the AE, Glaukos may request copies of the ophthalmic and medical records of the subject. If the subject was hospitalized for a study-treatment related unexpected adverse event, a copy of the discharge summary must be forwarded to Glaukos as soon as possible.

10.3 Suspected, Unexpected, Serious, Adverse Event (SUSAR)

A Suspected Unexpected Serious Adverse Reaction (SUSAR) is any AE for which there is evidence to suggest a causal relationship between the Travoprost Intraocular Implant and the AE, and which is assessed as both unexpected and serious. An unexpected adverse reaction, i.e. any untoward and unintended response to any of the study treatments, is one for which the nature and severity is inconsistent with the applicable reference safety information (e.g., Investigator's Brochure).

10.4 Adverse Events Follow-up

Adverse events will be followed and documented until the time of complete resolution, or resolution with sequelae, or exit from the study with an assessment of the outcome.

11 MAINTAINING THE MASK

This will be a masked study, in which the treatments will be unknown to the subject and the site staff performing certain measurements. All surgical study kits will be packaged in boxes labeled with the study number and unique kit number. All medication study kits will be packaged in boxes labeled with the study number and unique kit number. The study medications dispensed at a given site will be contained in bottles that are similar in size and cap color and packaged in identical study kit boxes. Both the bottles and the kit boxes will be labeled with the study number and unique kit number and dosing instructions.

CLINICAL PROTOCOL

Date: July 26, 2022	Phase: Phase 3 Study	Protocol No.: GC-012
------------------------	-------------------------	-------------------------

Glaukos must be informed of all instances where a subject's treatment was unmasked and the reasons for unmasking. In case of a medical emergency where it is necessary to know which study medication a subject received, the investigator may obtain the subject's treatment assignment.

12 INFORMED CONSENT

The investigator or designee will discuss the purpose and pertinent details of the study with each subject. The Informed Consent Form must be approved by the governing Institutional Review Board (IRB) or Independent Ethics Committee (IEC). Prior to undergoing any study related change in their treatment or any study related procedures, a subject must understand, sign, and date the appropriate IRB-approved Informed Consent Form. The signed and dated Informed Consent Form will be retained with the study records, and a copy of the signed Informed Consent will be given to the subject.

13 INSTITUTIONAL REVIEW

This study must be reviewed and approved by an appropriate Institutional Review Board (IRB) or Independent Ethics Committee (IEC). A copy of the letter indicating IRB approval must be provided to Glaukos (or designee) prior to study initiation. Updates must be provided to the IRB by the investigator at least annually or as required by the IRB.

14 CONFIDENTIALITY/PUBLICATION OF THE STUDY

The existence of this clinical study is confidential, and it should not be discussed with persons outside of the study. Additionally, the information in this document and regarding this study contains trade secrets and commercially sensitive information that is confidential and may not be disclosed unless such disclosure is required by federal or state law or regulations. Subject to the foregoing, this information may be disclosed only to those persons involved in the study who have a need to know, but all such persons must be instructed not to further disseminate this information to others. These restrictions of disclosure will apply equally to all future information supplied to you that is indicated as confidential.

The data generated by this clinical study are the property of Glaukos (the Sponsor) and should not be disclosed without the prior written permission of Glaukos. These data may be used by Glaukos now and in the future for presentation or publication at Glaukos' discretion or for submission to governmental regulatory agencies. Glaukos reserves the right of prior review of any publication or presentation of data from this study.

CLINICAL PROTOCOL

Date: July 26, 2022	Phase: Phase 3 Study	Protocol No.: GC-012
------------------------	-------------------------	-------------------------

In signing this protocol, the investigator agrees to the release of the data from this study, and acknowledges the above publication policy.

15 STATEMENT OF COMPLIANCE

This study will be conducted in compliance with the protocol, good clinical practices (GCP), and all applicable laws and regulations.

The clinical investigator must maintain all information supplied by Glaukos in confidence, and when this information is submitted to an institutional review board (IRB), independent ethics committee (IEC) or another group, it will be submitted with a designation that the material is confidential.

The clinical investigator must ensure that all persons assisting with the trial are adequately informed about the protocol, the investigational product(s), and their trial-related duties and functions.

16 RECORD KEEPING

16.1 Source Documents

The clinical investigator must maintain detailed source documents on all study subjects. Source documents include subject medical records, hospital charts, clinic charts, investigator subject study files, as well as the results of diagnostic tests (e.g., laboratory tests, visual field test printouts).

The following minimum information should be entered into the subject's medical record:

- The date the subject entered the study and the subject number
- The study protocol number and the name of Glaukos
- The date that informed consent was obtained
- Evidence that the subject meets study eligibility requirements (e.g., medical history, study procedures and/or evaluations)
- The dates of all study related subject visits
- Evidence that required procedures and/or evaluations were completed
- Use of any concurrent medications
- Documentation of study medication accountability, including a copy of study medication labels
- Occurrence and status of any adverse events
- The date the subject exited the study, and a notation as to whether the subject completed the study or was discontinued, including the reason for discontinuation

CLINICAL PROTOCOL

Date: July 26, 2022	Phase: Phase 3 Study	Protocol No.: GC-012
------------------------	-------------------------	-------------------------

16.2 Data Collection

The clinical investigator must maintain detailed records on all enrolled subjects. Data for enrolled subjects will be collected with an electronic data capture system. The electronic database, which is Title 21 CFR Part 11 compliant, will be managed by a data management vendor. Access to the database will be granted to authorize study personnel based on their role after training; and the access will be password-protected. The data clarification process will be managed within the electronic data capture system by either system-generated or manually generated electronic queries. Accuracy of data will be verified by source data verification at regular intervals, and all corrections to data will be made in the database. CRF forms are completed for all enrolled subjects, regardless of their final study status (e.g., subject discontinuation, study termination).

16.3 Study Supply Accountability

The principal investigator is responsible for ensuring that an inventory is conducted upon receipt of the clinical supplies and that the clinical study supplies are received and stored as instructed. The receipt of clinical supplies should be completed, signed, and returned as directed by Glaukos (or designee). A copy must be maintained at the site for the investigator's records. The principal investigator will keep a current record of the inventory and dispensing of all study medications. This record will be made available to the Glaukos monitor (or designee) for the purpose of accounting for all clinical supplies. Any significant discrepancy and/or deficiency must be recorded with an explanation. All supplies sent to the investigator must be accounted for and in no case will study medications be used in any unauthorized situation. It is the responsibility of the principal investigator to return or destroy any used and unused supplies to the Glaukos monitor (or designee) at the conclusion of the study.

16.4 Record Retention

All records relating to the conduct of this study are to be retained by the investigator until notified by Glaukos that the records may be destroyed.

The investigator will allow representatives of Glaukos' monitoring team (or designee), the governing institutional review board, the Food and Drug Administration (FDA), and other applicable regulatory agencies to inspect all study records, CRFs, and corresponding portions of the subject's office and/or hospital medical records at regular intervals throughout the study. These inspections are for the purpose of verifying adherence to the protocol, completeness, and exactness of the data being entered onto the CRF, and compliance with FDA or other regulatory agency regulations.

CLINICAL PROTOCOL

Date: July 26, 2022	Phase: Phase 3 Study	Protocol No.: GC-012
------------------------	-------------------------	-------------------------

17 REFERENCES

1.

[REDACTED]

CLINICAL PROTOCOL

Date: July 26, 2022	Phase: Phase 3 Study	Protocol No.: GC-012
------------------------	-------------------------	-------------------------

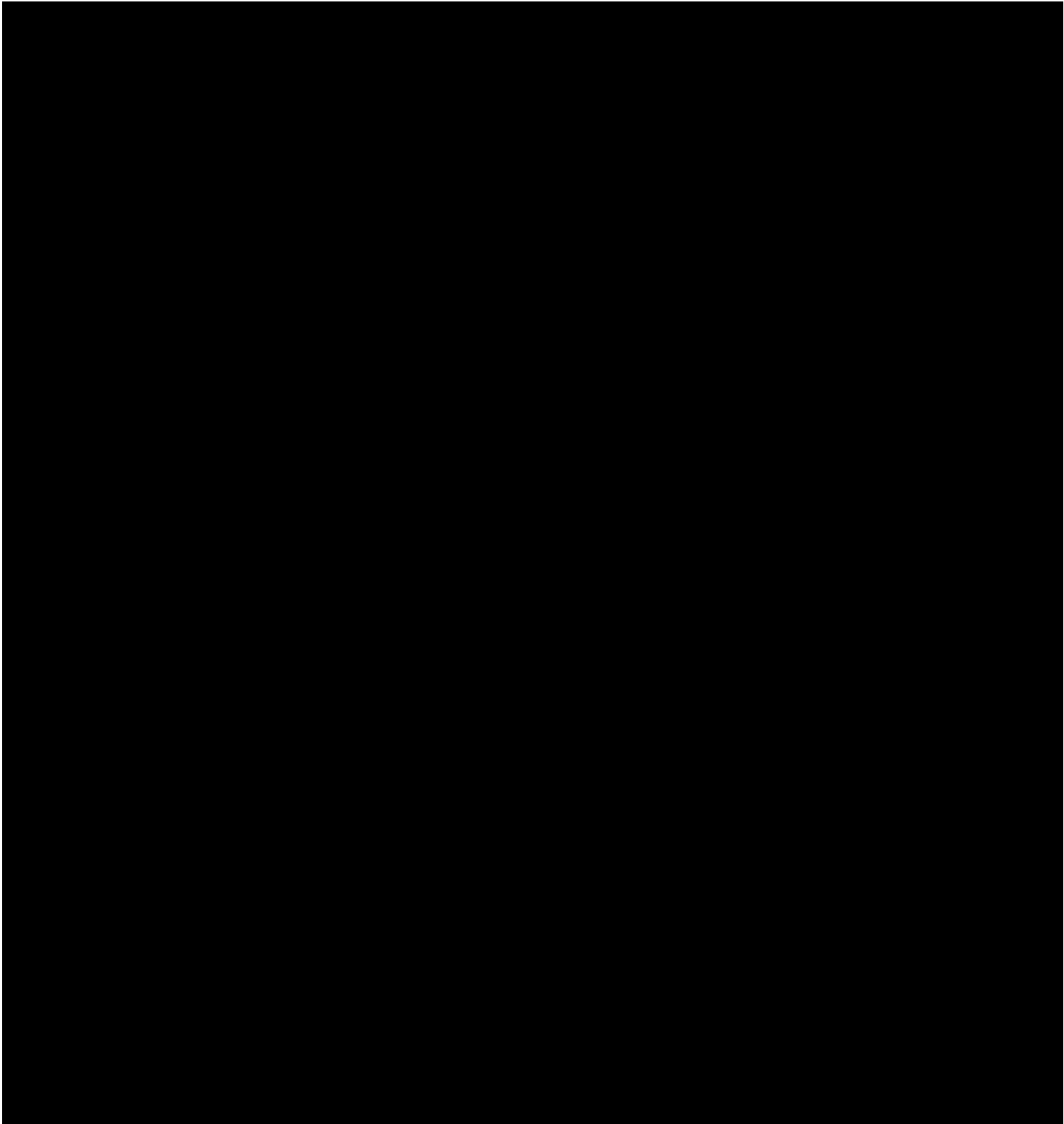

Visits with Diurnal IOPs are in Red

CLINICAL PROTOCOL

Date: July 26, 2022	Phase: Phase 3 Study	Protocol No.: GC-012
------------------------	-------------------------	-------------------------

APPENDIX B: OBLIGATIONS OF THE INVESTIGATOR

In summary, the clinical investigator has agreed to the following obligations:

- Obtaining informed consent from every subject prior to enrollment in the study and maintaining records of consent as part of the study records.
- Obtaining approval from the Institutional Review Board (IRB) before enrolling any subject; submitting verification of the approval to the Sponsor; submitting periodic progress reports (at least annually) and final report to IRB.
- Approving the protocol and conducting the study according to the protocol and applicable regulations; informing the Sponsor of all deviations from the protocol.
- Informing the IRB of all protocol amendments/modifications; sending the Sponsor a copy of the letter from the IRB approving the amendment/modification.
- Reporting to the Sponsor and the IRB any adverse experiences that occur in the course of the investigation.
- Keeping careful and accurate records of all clinical study data (study records must be considerably more exact and complete than those kept in ordinary medical practice); maintaining records of all materials submitted to the IRB and of all action by the IRB regarding the study.
- Making study records available for inspection by the Sponsor and representatives of the Food and Drug Administration; keeping records until notified by the Sponsor that they may be destroyed.
- Maintaining proper control and documentation of all test and control articles.
- Submitting the following records and reporting to the Sponsor (See I, II, and III).

I. Prior to Beginning the Study

- A signed Form FDA-1572 or Statement of Investigator.
- A current curriculum vitae (CV) if not submitted to Glaukos previously or if updated.
- CVs for all sub-investigators listed on the 1572.
- A letter from the Institutional Review Board (IRB) indicating that the protocol was approved, including the name and address of the IRB.
- A copy of the consent form approved by IRB.
- A list of current members of the IRB.

CLINICAL PROTOCOL

Date: July 26, 2022	Phase: Phase 3 Study	Protocol No.: GC-012
------------------------	-------------------------	-------------------------

II. While the Study is in Progress

- Acknowledgment of receipt of the test and control articles; documentation of disposition of all test and control articles.
- Original Case Report Forms for each subject enrolled in the study.
- Information regarding all deviations from the protocol.
- Information regarding all adverse medical events occurring to a subject while enrolled in the study.
- Annual progress report (if study is ongoing for more than one year).
Letter from the IRB indicating approval of the annual progress report.

III. Once the Study is Completed

- Disposition of all used and/or unused test and control articles, as well as documentation of all drug accountability.
- A final study report (if requested).

CLINICAL PROTOCOL

Date: July 26, 2022	Phase: Phase 3 Study	Protocol No.: GC-012
------------------------	-------------------------	-------------------------

APPENDIX C: DECLARATION OF HELSINKI

WORLD MEDICAL ASSOCIATION DECLARATION OF HELSINKI

Ethical principles for medical research involving human subjects

Adopted by the 18th WMA General Assembly, Helsinki, Finland, June 1964
and amended by the:

29th WMA General Assembly, Tokyo, Japan, October 1975

35th WMA General Assembly, Venice, Italy, October 1983

41st WMA General Assembly, Hong Kong, September 1989

48th WMA General Assembly, Somerset West, Republic of South Africa,
October 1996

52nd WMA General Assembly, Edinburgh, Scotland, October 2000

53rd WMA General Assembly, Washington DC, USA, October 2002 (Note of
Clarification added)

55th WMA General Assembly, Tokyo, Japan, October 2004 (Note of
Clarification added)

59th WMA General Assembly, Seoul, Republic of Korea, October 2008

64th WMA General Assembly, Fortaleza, Brazil, October 2013

Preamble

1. The World Medical Association (WMA) has developed the Declaration of Helsinki as a statement of ethical principles for medical research involving human subjects, including research on identifiable human material and data.

The Declaration is intended to be read as a whole and each of its constituent paragraphs should be applied with consideration of all other relevant paragraphs.

2. Consistent with the mandate of the WMA, the Declaration is addressed primarily to physicians. The WMA encourages others who are involved in medical research involving human subjects to adopt these principles.

General Principles

3. The Declaration of Geneva of the WMA binds the physician with the words, "The health of my patient will be my first consideration," and the International Code of Medical Ethics declares that, "A physician shall act in the patient's best interest when providing medical care."
4. It is the duty of the physician to promote and safeguard the health, well-being and rights of patients, including those who are involved in medical

CLINICAL PROTOCOL

Date: July 26, 2022	Phase: Phase 3 Study	Protocol No.: GC-012
------------------------	-------------------------	-------------------------

research. The physician's knowledge and conscience are dedicated to the fulfilment of this duty.

5. Medical progress is based on research that ultimately must include studies involving human subjects.
6. The primary purpose of medical research involving human subjects is to understand the causes, development and effects of diseases and improve preventive, diagnostic and therapeutic interventions (methods, procedures and treatments). Even the best proven interventions must be evaluated continually through research for their safety, effectiveness, efficiency, accessibility and quality.
7. Medical research is subject to ethical standards that promote and ensure respect for all human subjects and protect their health and rights.
8. While the primary purpose of medical research is to generate new knowledge, this goal can never take precedence over the rights and interests of individual research subjects.
9. It is the duty of physicians who are involved in medical research to protect the life, health, dignity, integrity, right to self-determination, privacy, and confidentiality of personal information of research subjects. The responsibility for the protection of research subjects must always rest with the physician or other health care professionals and never with the research subjects, even though they have given consent.
10. Physicians must consider the ethical, legal and regulatory norms and standards for research involving human subjects in their own countries as well as applicable international norms and standards. No national or international ethical, legal or regulatory requirement should reduce or eliminate any of the protections for research subjects set forth in this Declaration.
11. Medical research should be conducted in a manner that minimises possible harm to the environment.
12. Medical research involving human subjects must be conducted only by individuals with the appropriate ethics and scientific education, training and qualifications. Research on patients or healthy volunteers requires the supervision of a competent and appropriately qualified physician or other health care professional.

CLINICAL PROTOCOL

Date: July 26, 2022	Phase: Phase 3 Study	Protocol No.: GC-012
------------------------	-------------------------	-------------------------

13. Groups that are underrepresented in medical research should be provided appropriate access to participation in research.
14. Physicians who combine medical research with medical care should involve their patients in research only to the extent that this is justified by its potential preventive, diagnostic or therapeutic value and if the physician has good reason to believe that participation in the research study will not adversely affect the health of the patients who serve as research subjects.
15. Appropriate compensation and treatment for subjects who are harmed as a result of participating in research must be ensured.

Risks, Burdens and Benefits

16. In medical practice and in medical research, most interventions involve risks and burdens.

Medical research involving human subjects may only be conducted if the importance of the objective outweighs the risks and burdens to the research subjects.
17. All medical research involving human subjects must be preceded by careful assessment of predictable risks and burdens to the individuals and groups involved in the research in comparison with foreseeable benefits to them and to other individuals or groups affected by the condition under investigation.

Measures to minimise the risks must be implemented. The risks must be continuously monitored, assessed and documented by the researcher.
18. Physicians may not be involved in a research study involving human subjects unless they are confident that the risks have been adequately assessed and can be satisfactorily managed.

When the risks are found to outweigh the potential benefits or when there is conclusive proof of definitive outcomes, physicians must assess whether to continue, modify or immediately stop the study.

CLINICAL PROTOCOL

Date: July 26, 2022	Phase: Phase 3 Study	Protocol No.: GC-012
------------------------	-------------------------	-------------------------

Vulnerable Groups and Individuals

19. Some groups and individuals are particularly vulnerable and may have an increased likelihood of being wronged or of incurring additional harm.

All vulnerable groups and individuals should receive specifically considered protection.
20. Medical research with a vulnerable group is only justified if the research is responsive to the health needs or priorities of this group and the research cannot be carried out in a non-vulnerable group. In addition, this group should stand to benefit from the knowledge, practices or interventions that result from the research.

Scientific Requirements and Research Protocols

21. Medical research involving human subjects must conform to generally accepted scientific principles, be based on a thorough knowledge of the scientific literature, other relevant sources of information, and adequate laboratory and, as appropriate, animal experimentation. The welfare of animals used for research must be respected.
22. The design and performance of each research study involving human subjects must be clearly described and justified in a research protocol.

The protocol should contain a statement of the ethical considerations involved and should indicate how the principles in this Declaration have been addressed. The protocol should include information regarding funding, sponsors, institutional affiliations, potential conflicts of interest, incentives for subjects and information regarding provisions for treating and/or compensating subjects who are harmed as a consequence of participation in the research study.

In clinical trials, the protocol must also describe appropriate arrangements for post-trial provisions.

CLINICAL PROTOCOL

Date: July 26, 2022	Phase: Phase 3 Study	Protocol No.: GC-012
------------------------	-------------------------	-------------------------

Research Ethics Committees

23. The research protocol must be submitted for consideration, comment, guidance and approval to the concerned research ethics committee before the study begins. This committee must be transparent in its functioning, must be independent of the researcher, the sponsor and any other undue influence and must be duly qualified. It must take into consideration the laws and regulations of the country or countries in which the research is to be performed as well as applicable international norms and standards but these must not be allowed to reduce or eliminate any of the protections for research subjects set forth in this Declaration.

The committee must have the right to monitor ongoing studies. The researcher must provide monitoring information to the committee, especially information about any serious adverse events. No amendment to the protocol may be made without consideration and approval by the committee. After the end of the study, the researchers must submit a final report to the committee containing a summary of the study's findings and conclusions.

Privacy and Confidentiality

24. Every precaution must be taken to protect the privacy of research subjects and the confidentiality of their personal information.

Informed Consent

25. Participation by individuals capable of giving informed consent as subjects in medical research must be voluntary. Although it may be appropriate to consult family members or community leaders, no individual capable of giving informed consent may be enrolled in a research study unless he or she freely agrees.
26. In medical research involving human subjects capable of giving informed consent, each potential subject must be adequately informed of the aims, methods, sources of funding, any possible conflicts of interest, institutional affiliations of the researcher, the anticipated benefits and potential risks of the study and the discomfort it may entail, post-study provisions and any other relevant aspects of the study. The potential subject must be informed of the right to refuse to participate in the study or to withdraw consent to participate at any time without reprisal. Special attention should be given to the specific information needs of individual potential subjects as well as to the methods used to deliver the information.

CLINICAL PROTOCOL

Date: July 26, 2022	Phase: Phase 3 Study	Protocol No.: GC-012
------------------------	-------------------------	-------------------------

After ensuring that the potential subject has understood the information, the physician or another appropriately qualified individual must then seek the potential subject's freely-given informed consent, preferably in writing. If the consent cannot be expressed in writing, the non-written consent must be formally documented and witnessed.

All medical research subjects should be given the option of being informed about the general outcome and results of the study.

27. When seeking informed consent for participation in a research study the physician must be particularly cautious if the potential subject is in a dependent relationship with the physician or may consent under duress. In such situations the informed consent must be sought by an appropriately qualified individual who is completely independent of this relationship.
28. For a potential research subject who is incapable of giving informed consent, the physician must seek informed consent from the legally authorised representative. These individuals must not be included in a research study that has no likelihood of benefit for them unless it is intended to promote the health of the group represented by the potential subject, the research cannot instead be performed with persons capable of providing informed consent, and the research entails only minimal risk and minimal burden.
29. When a potential research subject who is deemed incapable of giving informed consent is able to give assent to decisions about participation in research, the physician must seek that assent in addition to the consent of the legally authorised representative. The potential subject's dissent should be respected.
30. Research involving subjects who are physically or mentally incapable of giving consent, for example, unconscious patients, may be done only if the physical or mental condition that prevents giving informed consent is a necessary characteristic of the research group. In such circumstances the physician must seek informed consent from the legally authorised representative. If no such representative is available and if the research cannot be delayed, the study may proceed without informed consent provided that the specific reasons for involving subjects with a condition that renders them unable to give informed consent have been stated in the research protocol and the study has been approved by a research ethics committee. Consent to remain in the research must be obtained as soon as possible from the subject or a legally authorised representative.

CLINICAL PROTOCOL

Date: July 26, 2022	Phase: Phase 3 Study	Protocol No.: GC-012
------------------------	-------------------------	-------------------------

31. The physician must fully inform the patient which aspects of their care are related to the research. The refusal of a patient to participate in a study or the patient's decision to withdraw from the study must never adversely affect the patient-physician relationship.
32. For medical research using identifiable human material or data, such as research on material or data contained in biobanks or similar repositories, physicians must seek informed consent for its collection, storage and/or reuse. There may be exceptional situations where consent would be impossible or impracticable to obtain for such research. In such situations the research may be done only after consideration and approval of a research ethics committee.

Use of Placebo

33. The benefits, risks, burdens and effectiveness of a new intervention must be tested against those of the best proven intervention(s), except in the following circumstances:
 - Where no proven intervention exists, the use of placebo, or no intervention, is acceptable; or
 - Where for compelling and scientifically sound methodological reasons the use of any intervention less effective than the best proven one, the use of placebo, or no intervention is necessary to determine the efficacy or safety of an intervention
 - and the patients who receive any intervention less effective than the best proven one, placebo, or no intervention will not be subject to additional risks of serious or irreversible harm as a result of not receiving the best proven intervention.

Extreme care must be taken to avoid abuse of this option.

Post-Trial Provisions

34. In advance of a clinical trial, sponsors, researchers and host country governments should make provisions for post-trial access for all participants who still need an intervention identified as beneficial in the trial. This information must also be disclosed to participants during the informed consent process.

CLINICAL PROTOCOL

Date: July 26, 2022	Phase: Phase 3 Study	Protocol No.: GC-012
------------------------	-------------------------	-------------------------

Research Registration and Publication and Dissemination of Results

35. Every research study involving human subjects must be registered in a publicly accessible database before recruitment of the first subject.

36. Researchers, authors, sponsors, editors and publishers all have ethical obligations with regard to the publication and dissemination of the results of research. Researchers have a duty to make publicly available the results of their research on human subjects and are accountable for the completeness and accuracy of their reports. All parties should adhere to accepted guidelines for ethical reporting. Negative and inconclusive as well as positive results must be published or otherwise made publicly available. Sources of funding, institutional affiliations and conflicts of interest must be declared in the publication. Reports of research not in accordance with the principles of this Declaration should not be accepted for publication.

Unproven Interventions in Clinical Practice

37. In the treatment of an individual patient, where proven interventions do not exist or other known interventions have been ineffective, the physician, after seeking expert advice, with informed consent from the patient or a legally authorised representative, may use an unproven intervention if in the physician's judgement it offers hope of saving life, re-establishing health or alleviating suffering. This intervention should subsequently be made the object of research, designed to evaluate its safety and efficacy. In all cases, new information must be recorded and, where appropriate, made publicly available.